

UF Ultra-Fab
The RV Lifting, Leveling, & Stabilization Experts

ULTRA-STORE

GUARANTEED SALE



RVs



Trailers



Displays



Plan-o-grams



The Ultra-Fab Story

From the beginning Ultra-Fab has been dedicated to putting the customer first. This is seen by our (1) always having the highest quality products as proven by our (2) always having the longest warranty, (3) providing important features that are exclusive to Ultra-Fab and (4) and by providing the best customer service in the RV and Trailering industries. With a history of providing quality products to the RV industry, Ultra-Fab is the best choice for quality products.

The jacks and stabilization experts

We have been making power tongue jacks since the 1970s. We have the only complete line of Kingpin stabilizers. We have the only slideout supports that cannot damage the slideout. We have the only scissor jacks with double nut design and the tightest threads in the industry. We have the only tongue jacks with a 10-year warranty. In fact most of our products have a lifetime warranty.



Ultra-Advantage

Indicates items where Ultra-Fab has exclusive benefits or has the longest warranties available on this product type



A reminder Ultra-Fab guarantees your sales. You will never get stuck with product that doesn't sell.



Calls attention to planograms designed with the top moving Ultra-Fab products

Always the longest warranty!



**Guaranteed
Sales**



What do we mean when we say “Guaranteed Sale”?

Simple. You will never get stuck with dead inventory from Ultra-Fab. Period. Whether you purchase individual products, planograms or displays, we guarantee you will sell the product. That's because we don't want you to take any risk when trying Ultra-Fab products. We guarantee your customers will love it. We guarantee the quality of the product. And we guarantee you will sell it.

We know what sells in the market. But we also know that no two dealerships are the same. So, if you have an Ultra-Fab SKU that doesn't sell for you within 12 months of purchase, we will gladly take it back and replace it with an item that does sell well for you. The claim does have to be made within 18 months of purchase and must be in resaleable condition, that way we can get it to a reseller that sells that product regularly and it is in acceptable condition for their customer.

What could be easier? Well, what if we paid the freight... both ways. Well, we do because we don't want you to take any risk when trying Ultra-Fab products. We guarantee your customers will love it. We guarantee the quality of the product. And we guarantee you will sell it.



Ask our competitors why they don't guarantee the sale



Tow Bars



Tow Force

An Ultra-Fab Product



- TOW WITH CONFIDENCE: Safe, stable, drama-free towing — because white-knuckle towing is just your rig politely begging you to make better life choices.
- HEAVY-DUTY 8,000 LB. TOWING CAPACITY: Real-world strength, not wishful thinking. Reliable, all-terrain towing performance on highways, campgrounds, dirt roads, and everywhere your wanderlust drags you.
- PREMIUM SOLID ALUMINUM CONSTRUCTION: Strong enough for serious towing, lightweight enough to install without needing a protein **shake first.**
- EASY OPERATION & QUICK STORAGE: Self-locking extendable legs automatically center and lock like towing magic. Non-binding handles make disconnecting a breeze. Fold the legs, latch them, and boom — it stows neatly on your motorhome.
- FULLY EQUIPPED & BUILT TO LAST: Heavy-duty safety cables and clevises for instant compatibility. Lifetime Warranty — because Ultra-Fab doesn't believe in "temporary."



New For
20
26

Amazingly Tough



Tow Bars



UF #	Description
35-946600	Tow Bar (8K, with Blue Ox Clevises)
35-946601	Tow Bar (8K, with Roadmaster Clevises)
35-946602	Tow Bar (12K, with Blue Ox Clevises)
35-946603	Tow Bar (12K, with Roadmaster Clevises)

Includes Clevis for desired baseplate



Farm Jacks



New For
2026

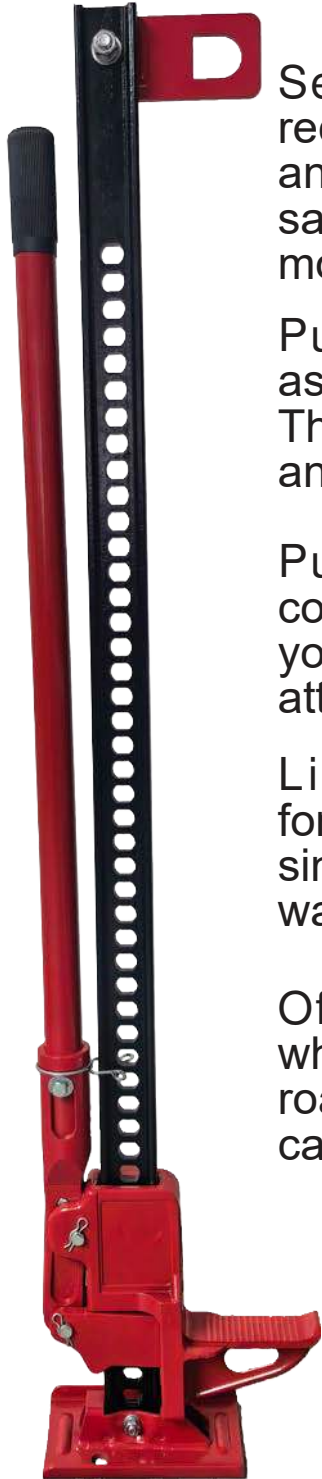

Serious Lifting: Perfect for off road recovery, stuck Jeeps, high clearance trailers, and farm machinery. Designed for mud, sand, and every “why won’t this thing move?” moment.

Pulling & Winching Powerhouse: Doubles as a manual winch—just add chains or straps. Think of it as your off road “come along,” but angrier and more determined.

Pushes & Spreads Like a Champ: Ideal for fencing, construction, and equipment repair. Because sometimes you need to persuade things apart with a little Ultra Fab attitude.

Lifts Sheds, Beams & Backyard Projects: Perfect for popping out fence posts that have been in the ground since the Eisenhower administration. Add chains and watch the magic happen.

Off-Road & Emergency Recovery Hero: Works where hydraulic jacks tap out. A must have in every off road kit. Can even help right a rolled vehicle (with extreme caution and zero heroics).

UF #	Description
38-944200	Farm Jack (48 inch, 8K)
38-944201	Farm Jack (60 inch, 8K)

Strong & Versatile



Farm Jacks



**Raises vehicles and equipment
higher than standard jacks**



Kingpin Stabilizers



Pinnacle Series Tripods by Ultra-Fab

UF# 19-950001
Steel Tripod for Fifth Wheel
Weighs only 23 lb.
5,000 lb. capacity
Adjust 34" - 52"

UF# 19-950200
Aluminum Tripod for Fifth Wheel
Weighs only 18 lb.
5,000 lb. capacity
Adjust 34" - 52"



Strongest Tripod in the industry (Steel only)



Self-adjusting legs for uneven surfaces



Fastest to set-up and take down



Sets up in less than 30 seconds

Buy 3 tripods get shelf-talker at No Charge

Ultra-Fab
The RV Lifting, Leveling, & Stabilization Experts
ELIMINATE MOVEMENT IN CAP OF FIFTH WHEEL



STRONGEST TRIPOD
STABILIZES FRONT-TO-BACK AND SIDE-TO-SIDE
AUTOMATICALLY ADJUSTS TO UNEVEN GROUND
FASTEST TO SET-UP



19-001093

Recommended Companion

Stores easily in tripod Carry-All Bag
UF# 19-950800



Why would you sell a tripod that is slower, weaker, doesn't self-adjust and doesn't have a lifetime warranty?



Kingpin Stabilizers



UF# 19-950450
Standard Tripod for Gooseneck
Weighs only 24 lb.
5,000 lb. capacity
Adjust 31" - 54"

- Largest footpad (5" x 5.5") combats sinking & tilting
- Heavy duty steel construction weighs only 24lbs, but has a capacity of 5,000lbs.
- Only gooseneck support recommended by Andersen Hitches and NSA Towing Products.

Buy 3 tripods get shelf-talker at No Charge



19-001093

Companion Product
Stores easily in tripod
Carry-All Bag
UF# 19-950800



UF# 19-950500
Standard Tripod for Fifth Wheel
Weighs only 24 lb.
5,000 lb. capacity
Adjust 31" - 54"

- Get out of bed without waking your partner
- Put into place and adjust chains to lock legs in place. Spin cup until snug
- Largest footpad (5" x 5.5") combats sinking & tilting
- Heavy duty steel construction weighs only 24lbs, but has a capacity of 5,000lbs.

Affordable and Effective Stabilizers



Kingpin Stabilizers



 **Widest Adjustment Range of any tripod 33" - 89.5"**

 **Largest footpad 5" x 5.5" combats sinking and tilting**

Heavy duty steel weighs only 25lbs, yet has a capacity of 1,200 lbs.

Get out of bed without waking your partner

Sets up in less than a minute with no tools needed. Simply pull up on the center chain and slip over catch. Spin hitch cup until snug. Adjust legs independently to ensure great connection to the ground

Buy 3 tripods get shelf-talker at No Charge



19-001093

Stores easily in tripod Companion Carry-All Bag
 UF# 19-950800



UF# 19-950600
 Tripod with Adjustable Legs



Tripod with the most range in the industry



Kingpin Stabilizer Accessories

UF# 19-950002

Extension Legs for steel tripods

Designed for Ultra-Fab models 19-950001, 19-950450 & 19-950500



- Perfect for storing a kingpin support, but versatile enough they can be used for a myriad of storage needs
- Prevents damage to tripod and prevents tripod from damaging other items
- Durable Oxford cloth saves wear and tear and keeps dirt and debris out of the compartment
- Velcro handle wrap
- 53.5" x 6.5" x 6.5"

UF# 19-950800

Storage Bag for tripods

Fits all known brands of tripods



Extension Legs for aluminum tripods

Designed for Ultra-Fab UF# 19-950202

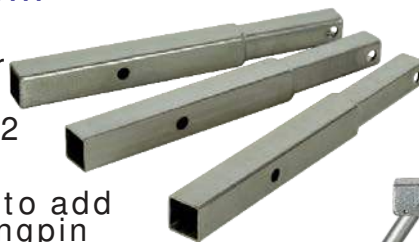

- The best way to add height to a Kingpin Stabilizer / Tripod
- Adds 6" to over height adjustment of Ultra-Fab Steel Kingpin supports
- Set of 3 leg extensions



Locking Cup

UF# 48-979008

Ball for tripod goosenecks

UF# 19-001057

Quality Accessories for quality products



Kingpin Stabilizer Tripods



Any item that doesn't sell in 12 months can be exchanged for Ultra-Fab product of equal value

Steel: For the ultimate in stabilization

Adjustable: For extremely tall or extremely short Fifth Wheels

Gooseneck: For Goosenecks & Adapters

Standard: When price is the only factor



UF# 19-950001	2 units	Steel
UF# 19-950500	2 units	Standard
UF# 19-950450	2 units	Gooseneck
UF# 19-950600	2 units	Adjustable
UF# 19-950800	10 units	Bag
UF# 53-945096	4 units	Shelf Strip
UF# 19-001093	1 units	Shelf Talker

UF# 19-000006
Tripod Planogram

Make more sales & make more profits



Landing Gear



UF# 17-943010
Landing Gear



Only Landing Gear with a 6-year warranty



Only Landing Gear with 12,000 lb. capacity (6,000 lb. per leg) for both lifting & supporting

Independent leg operation for true stability

Huge 8" x 5" footpad to prevent sinking and tilting

2 powerful legs allow for lifting, leveling & stabilizing

No more shoving rocks under one leg

No more hand cranking
Just flip the switch

- Total Travel 36" (21" screw travel & 17" drop leg travel)
- Overall length 36-1/2" (includes motor)
- Bracket height 36" retracted and 74" extended
- The frame clamp width 2"
- Screw travel 4" per minute

Built-in clutch prevents overextension



Replaces most brands of landing gear with ease



Landing Gear Accessories



UF# 17-940007 (Adjustable)
UF# 17-940006 (Fixed)

Landing Gear Footpad

- Eliminate trailer sinking
- Eliminate the search for wood
- Adjustable height, allowing each leg to make great connection with the ground (17-940007)
- Extra-large 8" x 5" surface area
- Heavy-duty steel construction
- Suggest purchasing one 19-940007 (Adjustable Footpad) and one 19-940006 (Fixed Footpad) as only one side needs adjustment



UF# 17-943031 (3/8")
Quick Pins

- Quickly adjust and lock in landing gear legs
- Spring loaded pin locks legs in place
- Easy bolt on installation
- Heavy duty zinc plated steel
- Installs in minutes
- 2 pack

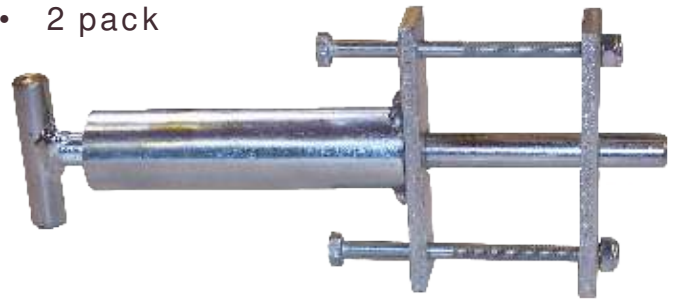

Perfect additions to your 5th wheel landing gear



Scissor Jacks



Ultra-Advantage

Exclusive
Twice the speed due to double-nut design



Ultra-Advantage

Exclusive
Easiest manual operation due to having the tightest threads



Ultra-Advantage

LIFETIME WARRANTY
And no one beats a lifetime warranty!

- UF# 48-979006 24" Single (No Handle)
- UF# 48-979002 24" Twin Pack (With Handle)
- UF# 48-979032 30" Single (No Handle)
- UF# 48-979031 30" Twin pack (With Handle)
- UF# 48-979100 Replacement Handle

Why sell scissor jacks without these features?



Scissor Jacks



Supports & stabilizes up to 6,500 lb. per jack
26,000 lb. per trailer when using 4 jacks

Bowtie design prevents sinking and improves stabilization

Bolt On or Weld On

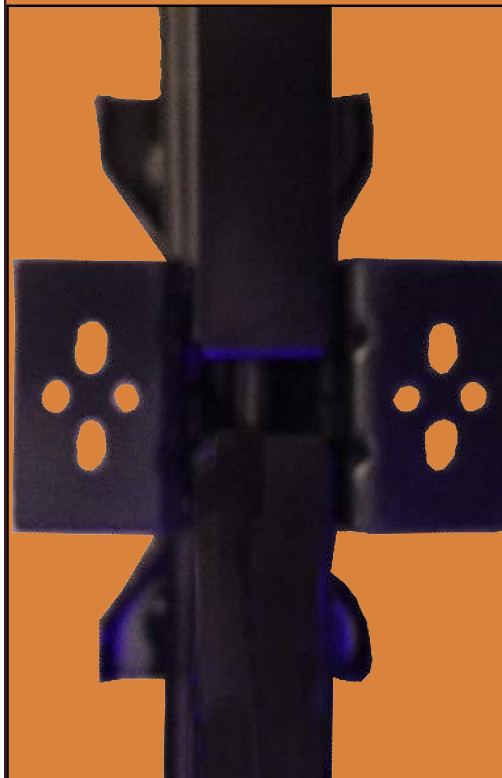

Heavier than the original, came with the shaft greased and works great. Very pleased with this product as it is better than the original.
Dan V

Good Quality, much sturdier than OEM ones. Very pleased with quality.
Steve W

My OEM units was too flimsy and bent after just a few seasons. These are solid built and I have used it now for several years with no issues.
Ray S.

Simply the best scissor jacks available!



Scissor Jacks

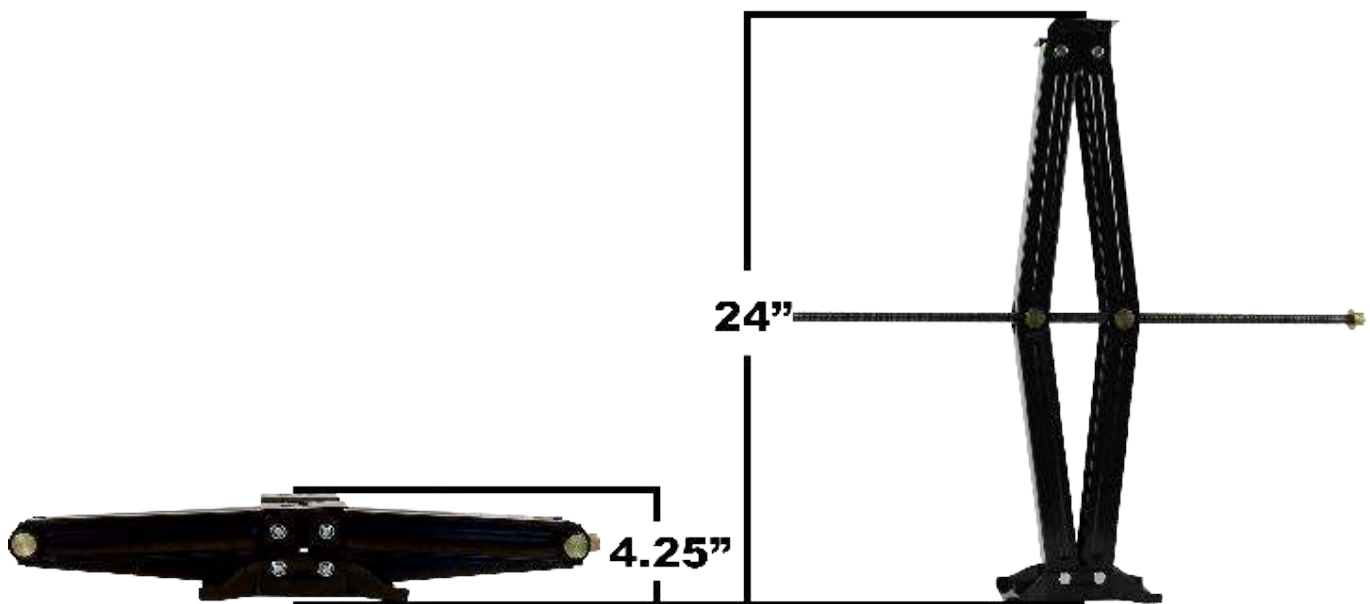
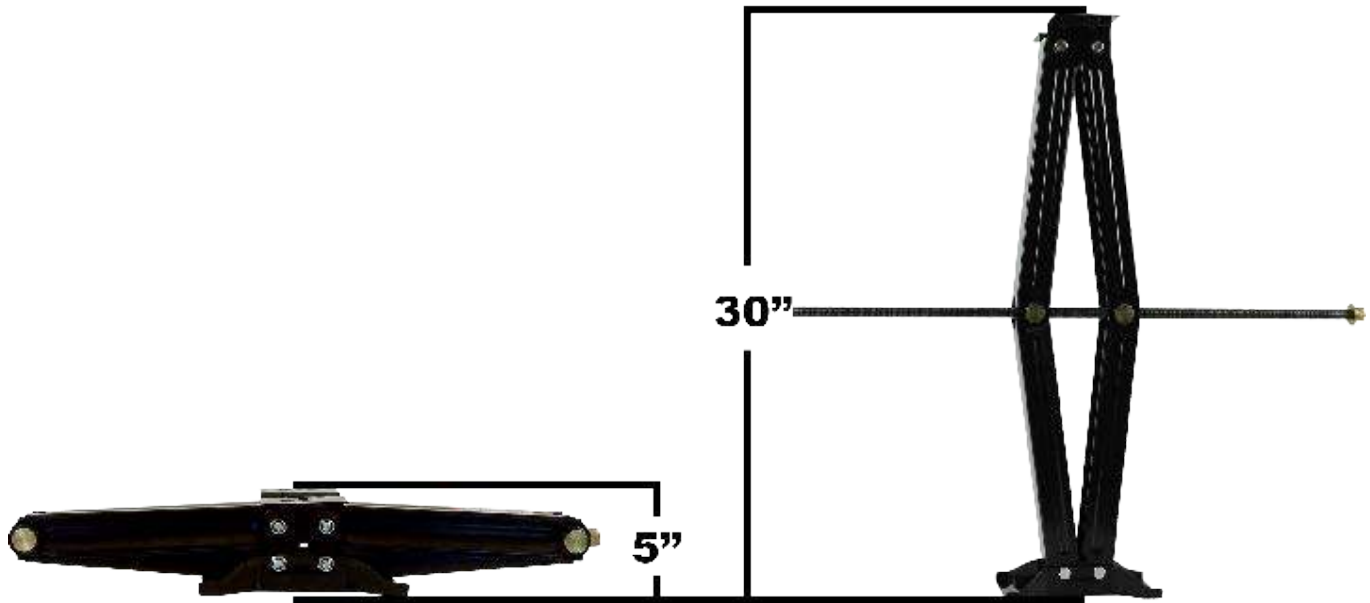

Huge range guarantees best stabilization



Scissor Jacks

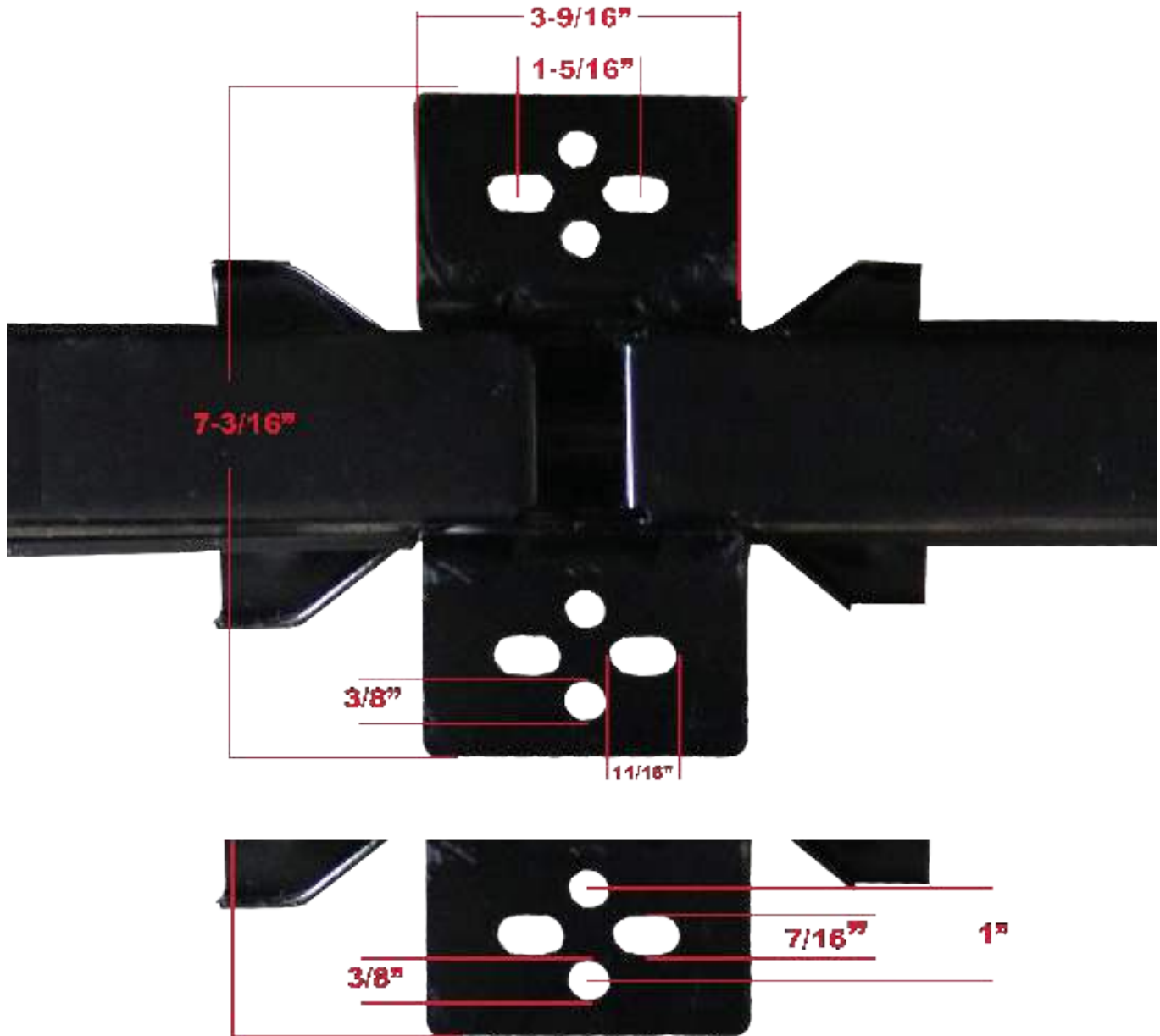

Universal mounting plate fits all known scissor jacks



Scissor Jack Accessories



- Eliminate strain and effort of manually operating scissor jacks or similar items.
- Tough zinc plated, all steel construction.
- **Adapter fits all 3/8" drills.**



Works great. Leveling our camper takes a whole lot less time now
Nancy H.

UF# 48-979005
Speed Socket
Hex socket design is ideal for Ultra-fab scissor jacks and other brands



Makes camp set up and stabilizing your camper a breeze... Sherri W.

UF# 48-979070
J Socket
With non-slip shank



This slotted drill stabilizer socket is one of the greatest camper's helper inventions ever designed. Drastically reduces set-up/tear-down time. Helps you start relaxing and enjoying your outdoor time faster...TP

UF# 48-979071
T-Slot
ID 5/8", OD 7/8".

**Not for use with impact driver
Not for use on Pop-Up camper mechanisms or Landing Gear Mechanisms
Only designed for scissor jacks**



Scissor Jack POP Items



Ultra-Fab
The RV Lifting, Leveling, & Stabilization Experts

Scissor jack damaged?
Need a stronger jack?
Need more stabilization in your RV?
Need a faster scissor jack?
Need a scissor jack that is easier to operate?

Time for a new scissor jack!

LIFETIME WARRANTY
No one can beat a lifetime warranty

Twice the speed
From exclusive double nut design

Easiest to manually operate
Tightest threads available

Super Stable
Huge footpad in bowtie design

For even easier operation
Try the Speed Socket

Extend or retract
10 times faster than manual operation

UF# 48-979091 Scissor Jack Planogram

- 2 each of all 4 models
- 2 each of the 3 drill adapters
- Shelf Strips
- Shelf Talker or Gondola sign

Ultra-Fab
The RV Lifting, Leveling, & Stabilization Experts

30" Scissor Jack
Single Pack
26,000lb capacity across 4 jacks
6,500lb capacity

Scan for more information

Speed Socket 10x

Ultra-Slot

24" Scissor Jack
Single Pack
26,000lb capacity across 4 jacks
6,500lb capacity

Stabilize your RV or trailer to ensure a more comfortable feeling inside

Ultra-Fab
The RV Lifting, Leveling, & Stabilization Experts

Upgrade to better stabilizations

Full 6,500lb capacity per jack
Twice as fast due to exclusive double nut design
Easiest manual operation due to exclusive super tight threads

30" Scissor Jack
Single Pack
26,000lb capacity across 4 jacks
6,500lb capacity

30" Scissor Jacks
Double Pack
26,000lb capacity across 4 jacks
6,500lb capacity

RVing is meant to be enjoyable... We're making it that way!

Shelf Talker
Buy any 4 scissor jacks get shelf talker at No Charge
48-979090

Ultra-Fab
The RV Lifting, Leveling, & Stabilization Experts

Stabilize your RV
Better than original equipment jacks

Full 6,500lb capacity per jack
Twice as fast due to exclusive double nut design
Easiest manual operation due to exclusive super tight threads

LIFETIME WARRANTY

Need more information? Scan here



Never get stuck with inventory that doesn't move for you.

Any item that doesn't sell within 12 months can be exchanged at no cost to you

You never get stuck with unsellable product



Stacker Jacks



UF# 48-979003 2 pack

UF# 48-979004 4 pack

Stacker Jacks

Superior support for a variety of applications.

Amazingly tough die cast aluminum construction.

Extends from 11" to 17". Perfect for trailer stabilization.

Easy to set up and adjust.

Adjustable handles.

Stackable units take up minimal storage space. 6,000lb capacity each.



Round out your scissor jack offering



Power Twin



Eliminates motion both front-to-back and side-to-side

2 powerful legs allow for lifting, leveling & stabilizing

6,000lb capacity per leg
12,000 per unit
24,000 per RV (when using 2)



Switch easily mounted to RV frame or side



Independent leg operation for true stability even on uneven surfaces

- Best-in-class trailer stabilizer was built to make life easier for practically all trailer types.
- Mount one in front and one on rear for extreme stabilization.
- Legs extend 22" or 30" depending on model.



UF# 39-941707 22"
UF# 39-941705 30"

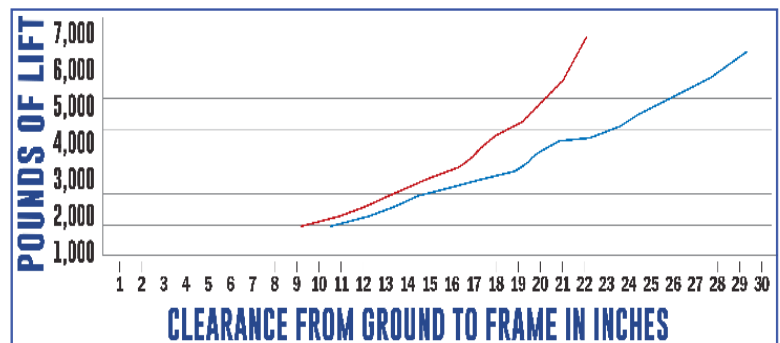

Dual Motor Operation

No product stabilizes travel trailers better



Leveling Blocks



STRONGEST
Leveling Blocks
on the Planet

 Only Leveling Blocks with a Lifetime Warranty



Blue color stands out
Not easily lost

Easily remove debris
by knocking it off or
hosing them down

Blocks measure
8 1/4" x 8 1/4"

Strongest leveling
blocks on the market

Interlocking blocks
easily stack for
perfect height
1" high each

Easy to store with
zippered bag
provided

Comes in handy
carrying/storage bag

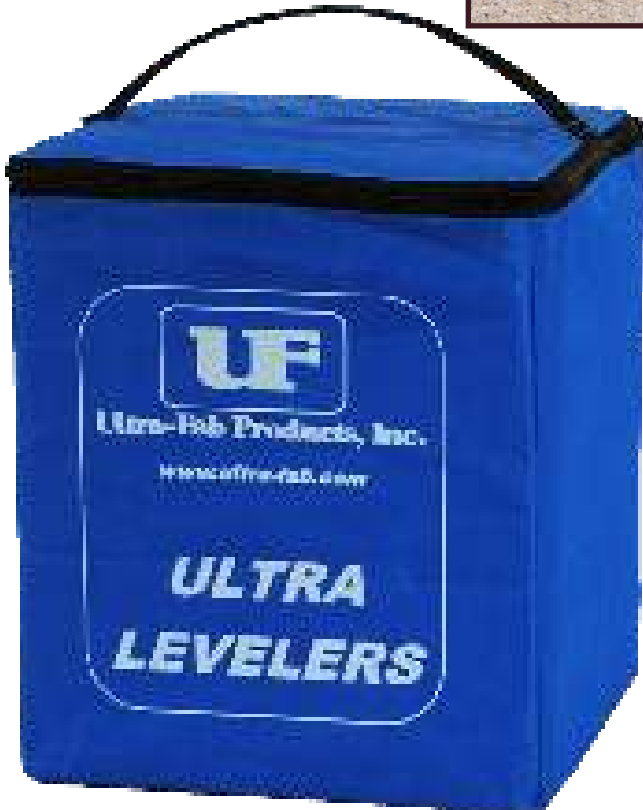

- UF# 48-979050 4/pk
- UF# 48-979052 8/pk
- UF# 48-979051 10/pk

Yes, we said "lifetime warranty"



Eliminator II



Eliminate
movement
on any travel
trailer that uses
scissor jacks

Works on all known 24"
and 30" scissor jacks
except Low-Pro models.

Automatic
Moves and locks in to
place when operating
scissor jacks



Front-To-Back and/or Side-To-Side



Eliminator



**Eliminates
Side-to-Side
movement**

UF# 48-979081

Connects
between 2 front
scissor jacks
or 2 rear
scissor jacks

**Eliminates
Front-to-Back
movement**

UF# 48-979081

Connects
between any
scissor jack
and the
trailer frame

Use both for ultimate stabilization



Eliminator II



Eliminator II Side to Side UF# 48-979081

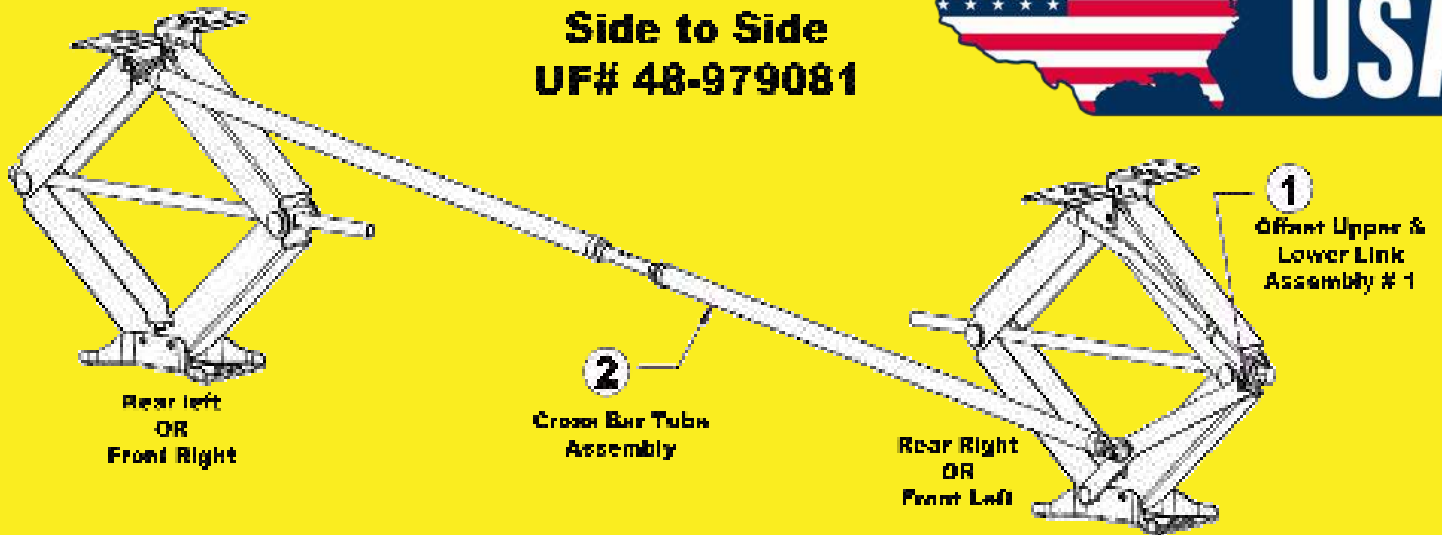

Eliminator II Front-to Back UF# 48-979080

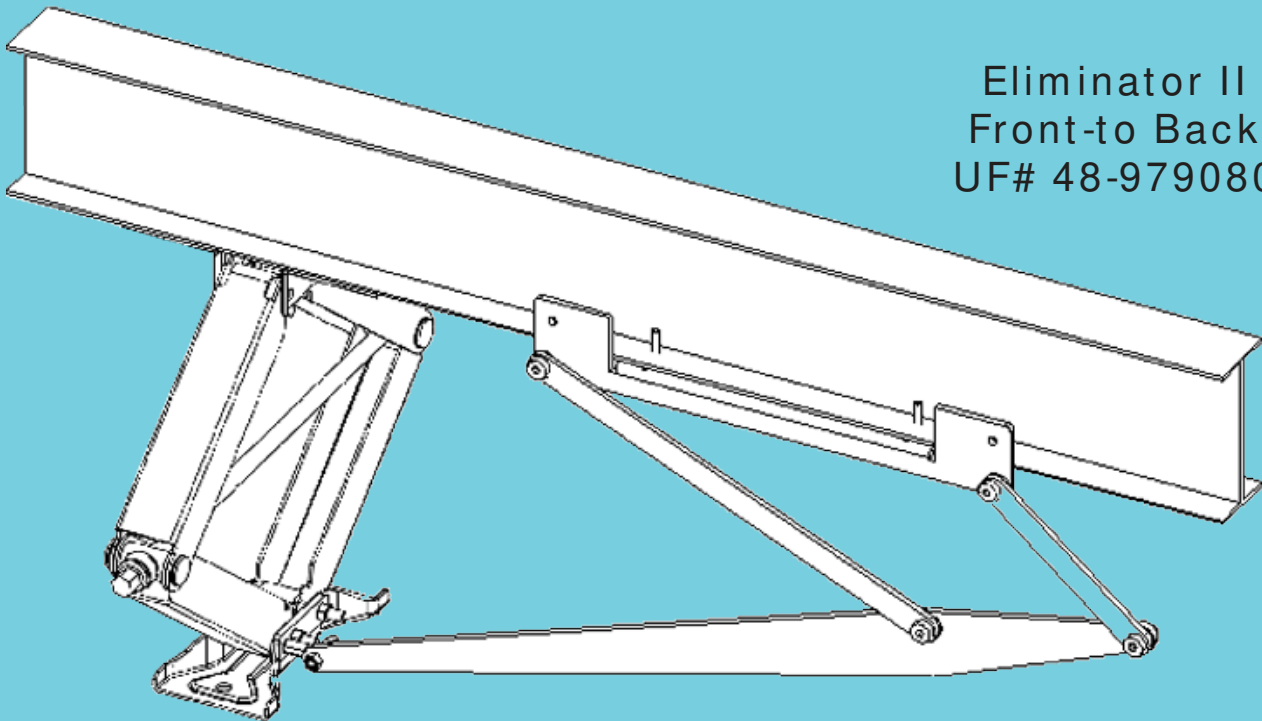

Easy install and even easier use



Slideout Supports



Prevents
damage
caused by
excess weight
and movement
in slideout area

Prevents
sag
common
to aging
slideouts



Spend a little now, Save a lot later



Slideout Supports



Problem: Slideout supports with handles can be overtightened. This causes a separation between slideout and RV.



Ultra-Advantage

Only support that cannot damage the slideout



Ultra-Advantage

Only support with nylon nut. Will strip before damaging the slideout.

Lifetime Warranty: If nut ever strips, contact Ultra-Fab for replacement.

Only support that cannot damage the slideout



Slideout Supports



FAST
Set up or
take down
in less
than 10
seconds
each

Quick
and easy
adjustment

- 19-960003 adjust from 26" - 47"
- 19-960002 adjust from 21" - 37"
- 19-960001 adjust from 16" - 28"



**LIFETIME
WARRANTY**
No one can beat a
lifetime warranty

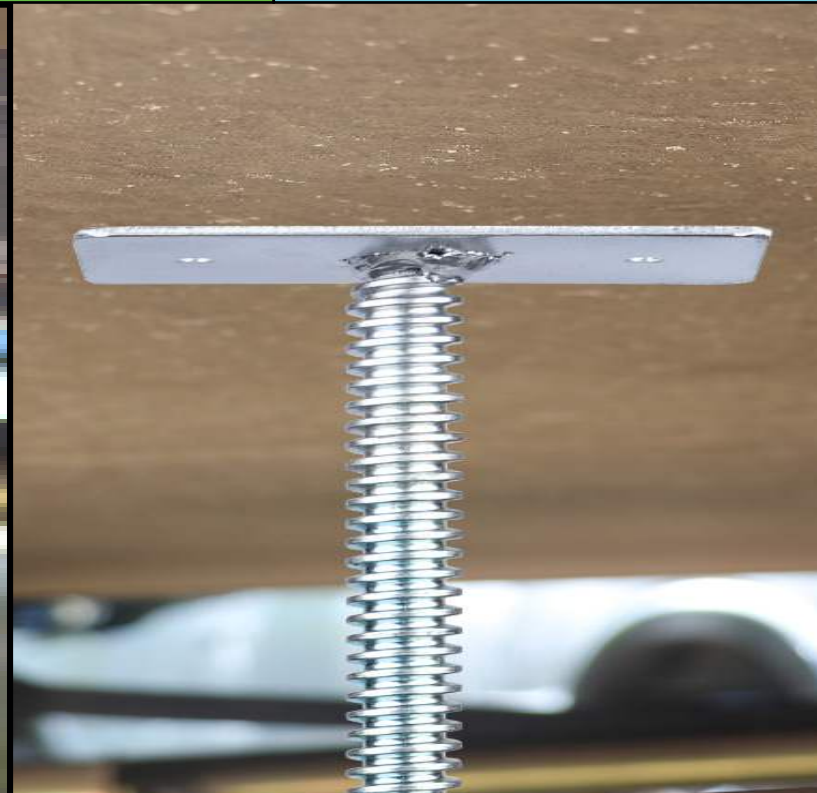

Fast, Easy & Guaranteed



Slideout Supports

Shelf Talker
with QR Code
19-960101
Buy 2
Get shelf talker
at no charge

Ultra-Fab
The RV Lifting, Leveling, & Stabilization Experts
THE ONLY SLIDE-OUT-SUPPORT THAT CANNOT DAMAGE THE SLIDE-OUT

SAVES WEAR AND TEAR ON SLIDE OUTS
HELPS PREVENT COSTLY SLIDE OUT AND FRAME REPAIRS
QUICK RELEASE BUTTON MAKES ADJUSTMENTS

LIFE TIME WARRANTY

Planogram
19-960005

Includes
2 of each slideout supports
2 Storage Bags
1 shelf talker with QR code
1 shelf strip



Packaging
That draws
attention
Also has QR
code to video



Related Product
Storage Bag for
slideout supports
19-960005



Make more money!



Slideout Supports



Retail Video
For you dealership
For your website

Training Video

- For Parts Personnel
- Service Advisors
- And others



One of my biggest complaints in our camper is the movement when we walk around. Nothing we have tried has fixed that. Until now. These stabilizers took out that movement by holding the slide steady. You saw no movement outside where typically we would see the slide moving. I would highly recommend this to any camper. They are easy to use and quick to put up and take down. - Melanie

Especially with two teenagers in the RV, the weight we put on our dining room slide (which also includes our living room couch) can be excessive. This slide support is great for preventing sag and shaking. It's so quick and easy to setup, take down and store, it has turned into a must have for us when we RV. We bought more so that ALL of our slides are now stabilized! - Chris

These supports are well made, easy to use, take up little space and do wonders to dampen the rocking motion of our rig. I was able to place them under the sides of the slideout when I took the rig out last time and they really stopped a lot of the rocking motion. - D.B.

We really enjoyed these trailer slide stabilizers. They are very effective, easy to set up and take down. They are slim and collapse down so they do not take up much space in your storage areas. We recommend to all our friends. - Justin

The push button release is great because you don't have to worry about spinning it a million times to get it undone. - Amanda

We have an 80lb bulldog that can get crazy and definitely noticed a difference in the movement of camper when he gets the zoomies in a small enclosed space. We look forward to using these on all future camping trips. - Kasey

Don't take our word for it



Ultra-Series Tongue Jacks



Companion Product
Stores easily
in tripod
Carry-All Bag
UF# 19-950800



-  Patented Zerk Fitting only available with Ultra-Fab
-  First & Only jack with greaseable shaft for maximum life
-  No one beats our 5-year warranty

UF# 38-944060
3,500 lb. capacity
 • Total travel is 23.5"
 • **Tube size fits 2 1/2"** couplers
 • Speed is 10" in 50 seconds
 • Lighting by Dual Site-Lites™

UF# 38-944037
3,500 lb. capacity
 • 7-way plug
 • Total travel is 18"
 • **Tube size fits 2" or 2 1/2"** couplers
 • Speed is 10" in 50 seconds

UF# 38-944014
4,000 lb. capacity
 • Total travel is 23.5"
 • **Tube size fits 2 1/2"** couplers
 • Speed is 10" in 40 seconds
 • Lighting provided powerful LED lamp

Pay \$5 more, get 5 times the warranty



Phoenix Series Tongue Jacks



 Longest Warranty
of any Tongue Jack
Ultra-Advantage



 Fastest tongue jack
10" in 18 seconds
4,000lb model only
Ultra-Advantage

Quiet Please
No other jack
is this silent

 The quietest
tongue jack ever
made 4000lb
model only
Ultra-Advantage



 Only Ultra-Fab
makes a 5500lb
tongue jack
Ultra-Advantage



 Largest footpad
(7" on 5,500lb)
Prevents sinking
Ultra-Advantage



 Largest lift range
26.5"
5,500lb model
Ultra-Advantage



Auto extend
Auto retract



Remote Control
included on
5500lb model



Amazingly
bright light for
easy nighttime
operation

UF# 38-944040
4,000lb model, 23.5" total travel

UF# 38-944055
5,500lb model, 26.5" total travel



Tongue Jack POP



THE RIGHT PRODUCTS TO HELP YOU MAKE MORE MONEY

Buy 4 jacks, get jack gondola display at no charge

Includes custom designed shelf, header card and trifold.

Gondola Jack Display

- UF# 38-944100 (Madix 3')
- UF# 38-944101 (Madix 4')
- UF# 38-944102 (Lozier 3')
- UF# 38-944103 (Lozier 4')



Get the customer's attention & make the sale



Manual Tongue Jacks



Sidewind Manual Jacks

Reliable jack made with heavy duty steel construction and metal gears. E-Z grip rotating handle for easy operation. Universal **mounting flange and 3/8"** bolts. Durable powder-coated finish.

UF# 49-954030 1000 lb. capacity
UF# 49-954031 2000 lb. capacity



Topwind Manual Jacks

Reliable jack due to heavy duty steel construction and metal gears. E-Z grip rotating handle for easy operation. Universal **mounting flange and 3/8"** bolts. Durable powder coated finish.

UF# 49-954050
Ultra Topwind Tongue Jack, 2 1/4" tube, 5,000 lb.

UF# 49-954032 1,000 lb.
UF #49-954033 2,000 lb.

Marine Jack

Perfect jack for most boat trailers. Reliable operation due to all metal gears and heavy-duty steel construction. E-Z grip rotating handle for easy operation. Universal mounting **flange. Worm** gear mechanism designed not to slip. Wheel attached. Mounting hardware included.



UF# 49-954034

Get the customer's attention & make the sale



Tongue Jack Accessories

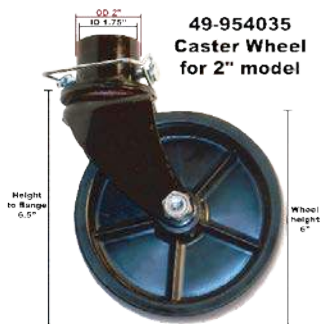

Caster Wheels

Smooth movement due to nylon bearings. Tough plastic wheel for reliable operation. Easy attachment via cross and pin clip (included). Durable powder coated finish. **Fits 2" jacks.**

UF# 49-954035 for 2" model
UF# 49-954036 for 2.25" model

Footpads

Great footpad for your manual tongue jack. Designed to keep the jack from sinking. Heavy Duty construction and **durable powder-coat finish for years** of reliable use. Easy installation. Secures with included pin/clip. 1-7/8" inside diameter x 2" outside diameter. 49-954037

UF# 49-954037 for 2" model
UF# 49-954038 for 2.25" model

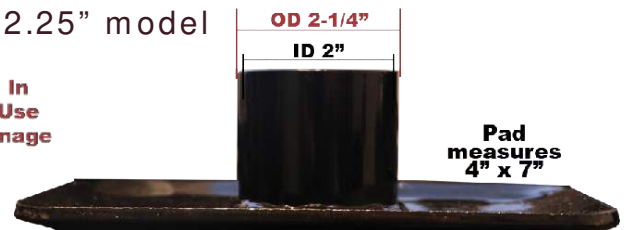

UF# 49-954037 for 2" model

We even know Manual Jacks



Ultra Chock N Lock

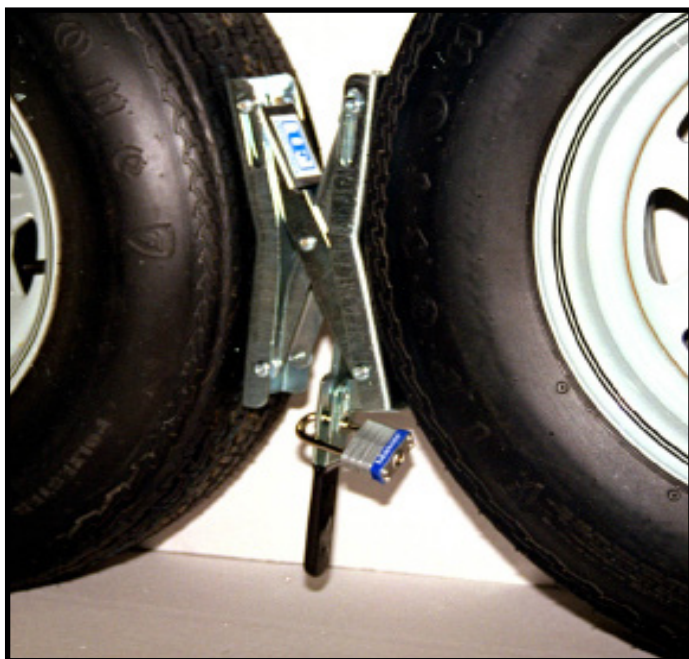

UF# 21-001060 1/pk
UF# 21-001070 2/pk
UF# 21-001080 XL 1/pk

- Works by anchoring the opposing wheels of tandem axle trailers
- Lockable to prevent theft (Padlock not included)
- E-Z Grip handle creates better leverage
- Super Grip tire louvers reduce slip
- Collapses to just 1.5" / expands to 5.25"
- XL collapses to 4.5" / expands to 10"



Why sell a chock without a lifetime warranty?



Super Grip Chocks

Only chock with padlock included at no charge



Only chock with handle secured at both ends

Lifetime warranty

- UF# 21-001090 (1" - 10.25") 1/pk
- UF# 21-001091 (1" - 10.25") 2/pk
- UF# 21-001094 (3.5" - 17") 1/pk
- UF# 21-001095 (3.5" - 17") 2/pk



Buy 4 SuperGrips get shelf talker at No Charge



21-001011

Companion Product
 Stores easily in tripod Carry-All Bag
 UF# 19-950800



The most advanced tire locking chocks



Skid Rollers



Hitch Mount Steel Rollers

- Prevents damage to motorhome undercarriage caused by tail dragging or digging in to the ground
- Bolts to 2-1/2" or 3" square receiver hitch tubing
- Contacts ground when motorhome would drag or dig into ground
- Heavy duty steel construction is super durable to accept the impact
- Not recommended for use on diesel pusher motorhomes due to the extreme rear-end weight of the motorhome.
- **Grease zerk fitting to maximize lifespan**
- 2 per carton
- "2.25" wheel width x 2.9375" wheel diameter, 1/4" mounting bracket
- Comes with all mounting hardware

UF# 48-979017 - Fits 2.25" hitch bars



Receiver Mount Steel Rollers

- Heavy duty receiver protector attaches with pin and clip or with hitch lock.
- Does not require removal of ball mount or other hitch-mounted accessories.
- 2.25" Wheel Width, 2" Diameter
- Fits 2" x 2" trailer hitch receivers
- Pin hole 5/8"

UF# 48-979020

No skid wheel or roller is recommended for diesel pusher motorhomes due to extreme weight in the rear of motorhome.

Built to take the impact



Skid Wheels



Skid Wheels Swivel / Weld-on

- Drop forged caster provides superior strength
- Ultra strong metal wheel includes roller bearings and .25" urethane on outer edge
- Simple bolt-on installation
- **Zerk fitting for maximum life.**
- Simple bolt-on installation.



UF# 48-979012 5" Swivel (7.25" tall)



Weld-On Steel Rollers

- Weld-on steel roller
- Grease Zerk to maximize lifespan
- One per carton
- 1/4" steel mounting bracket



2" wheel width x 2" wheel diameter

UF# 48-979021 Retail pack

UF# 48-979060 Bracket Only, 20/pk bulk

UF# 48-979061 Roller Only, 20/pk bulk

1.5" wheel width x 2.5" wheel diameter

UF# 48-979022 Retail pack

UF# 48-979062 Bracket Only, 20/pk bulk

UF# 48-979063 Roller Only, 20/pk bulk

2.5" wheel width x 3" wheel diameter

UF# 48-979023 Retail pack

UF# 48-979064 Bracket Only, 20/pk bulk

UF# 48-979065 Roller Only, 20/pk bulk



Perfect roller or skid wheel for any need



Storage and Covers



UF# 19-960004
Slide-out Supports



UF# 21-001097
Tire Locking Chocks



UF# 19-950800
Kingpin Stabilizers Tripods

- Keeps dirt out of compartments
- Stops stabilizers from damaging other items in compartment
- Holds all known brands

- Perfect for storing other items
- Made of durable Oxford cloth
- Saves wear and tear

Jack Covers

- Protects jack from the elements
- A second barrier to protect jack from water & sun damage
- Oxford cloth is known to repel water & sunlight



Standard
UF# 38-944020

Large
UF# 38-944026

Oxford cloth is known for its water impermeability



Solar Vent



- Solar powered for simple use
- Fits all known plumbing exhaust
- Powerful fan removes tank smell
- Easiest way to keep RV smelling fresh



UF# 53-945001
Plumbing Vent Fan
(Solar Powered)

Easiest way to sell Solar Powered Plumbing Vents



Buy 6, get
displayer at no
charge

UF# 53-945082
6 pk with displayer



Runs whenever the sun shines



Cargo Carriers



Trailer Mounted Accessory Adapter

Used for bike and cargo carriers. Engineered to fit most recreational vehicle frames including I-beam, C-channel, and rectangular sections. Heavy duty steel construction. Durable powder-coated finish. Adjusts from 47.125" to 77". 350# tongue weight capacity.

UF# 35-946403

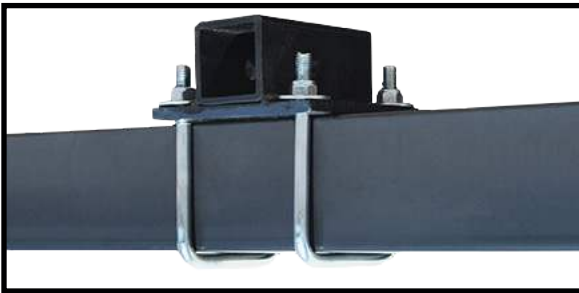

RV Bumper Receiver Adapter

Fits 4" square RV bumpers. **Durable powder-coated finish** 200# tongue weight capacity. Accepts 2" carrier tubes. Zinc plated hardware included. Not recommended for towing.

UF# 35-946401



Universal RV Bumper Hitch

3,500# towing capacity. 350# tongue weight capacity. 2" square receiver opening. U-Bolts mount to 4" square bumpers. Easy bolt-on installation. Durable powder coated finish.

UF# 35-946402

Use your hitch to allow for more storage



Cargo Carriers



Cargo Carrier

Expand your carrying capacity by using this hitch-mounted cargo carrier. Easily carry 500#. The metal mesh platform eliminates standing water. Convenient tie-down utility holes. Fits 2" receiver hitches. 19.25" x 60"

UF# 48-979029



Tow Dolly Tie Down Strap

Securely transport your car **on a dolly. Quickly fits and** adjusts to 14" to 16" tire sizes. One-piece design – no pre-assembly required. Tough, non-abrasive nylon metal hooks attaches on driver's side or passenger's side. Durable 5,000# capacity. Compatible with most tow dollies. One per package.



UF# 46-700034



Spare Tire Carrier - Universal

Carry a spare just in case... **Easily converts from fixed to** fold-down for easy access to rear storage compartment. Bolts to 4" square bumpers only. Designed to minimize tire vibration. Includes all items for set-up and use. 60# capacity. 1-year warranty.

UF# • 15-954730

Bike Rack

Attaches to Ultra-Fab and other brands of cargo carriers to provide a safe and stable ride for your bicycles. Rugged steel construction and durable powder coated **finish for years of reliable** service and good looks. Convenient tie-down strap included. Lightweight for easy mounting. Installs easily in just minutes.

UF# 48-979030

Secure your cargo for peace of mind



MegaHitch Coupler Lock



Not just a coupler
lock It's a coupler

VAULT



UF# 35-946510

Fits 2" & 2-5/16"
hitch balls

Adjustable
high-density ball

Solid steel
design

Loved by
Airstream
customers &
many others

Strongest coupler locks available



MX Hauler



MX Hauler

Securely hold dirt bike for transport or making repairs. Heavy Duty steel construction ensures it stays in place. Easy assembly, bolts together. Mounts in standard 2" receivers. Ramp works on either side of carrier. Durable powder-coated finish. **500# load capacity.**

UF# 48-979033

Easy one person loading



Easy one person unloading



Easily fits in 2" receiver hitches



Take your dirt bikes & have some fun



Insect Screens

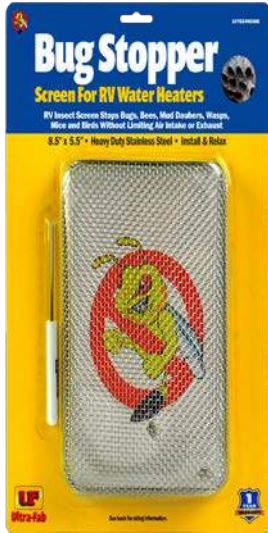

8.5" x 5.5"
UF# 53-945400



8" x 1.5"
53-945220



9.5" x 7"
UF# 53-945410



10.5" x 4"
UF# 53-945300



20" x 1.5"
UF# 53-945200



27.5" x 1.38"
UF# 53-945230

All applications available



Bug Stoppers



Close screen mesh keeps out mud daubers, wasps & mice

Simple to install

Does not block air flow



2.75" Round
UF# 53-945110



4" Round
UF# 53-945130



4.75" x 4.5"
UF# 53-945120

 Bright / Noticable packages gets your customer's attention

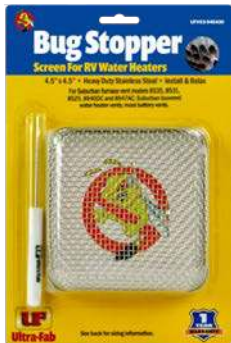

4.5" x 4.5"
UF# 53-945430

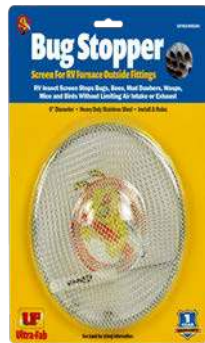

6" Round
UF# 53-945140



6.5" x 6.5"
UF# 53-945420

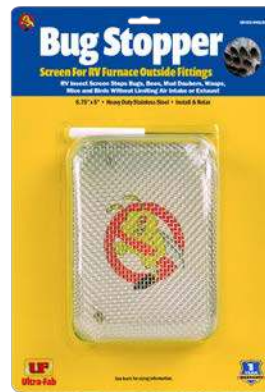

6.75" x 5"
UF# 53-945150

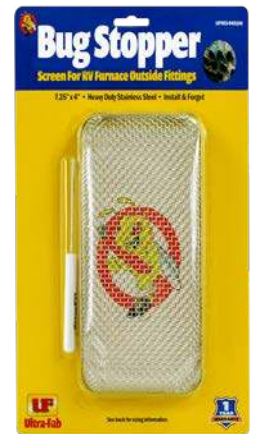

7.25" x 4"
UF# 53-945100

All applications available



Insect Screens



Every dealer that has this planogram reports a 50% increase in screen sales in first 6 months



Top Selling Screens
UF# 53-000003



Only the 10 most popular



Bug Stoppers



Application and cross references are to best of our knowledge. Some models vary slightly.

Designed to fit	Measurements	UF	Legacy	Combo	Valterra	JR Products	Westair	JCU
Furnace Atwood AFND	6.75" x 8"	33-945190	None	42185	A18-1305VP	08-30245	88580	None
Furnace Atwood Hydroflame with access door	4" Round	33-945130	FUR200	42144	A18-1304VP	08-30205	88502	N-500 R-1400
Furnace Atwood Hydroflame without access door	4.75" x 4.5"	33-945120	FUR200	42143	A18-1302VP	08-30205	88504	N-500
Furnace Columbia, Suburban, Bell Aire, Hydroflame Furnace models	7.25" x 4"	33-945100	FUR100	42140	A18-1300VP	08-30185	88297	None
Furnace Durotherm & Suburban	2.75 Round	33-945110	FUR200	42141	A18-1304VP	08-30195	88525	N-300
Furnace Suburban DD Series	5" Round	33-945140	FUR400	42143	A18-1303VP	08-30275	88307	N-700
Rango Atwood, Westwood, Mega200 & Suburban, Degrin	10.5" x 2"	33-945300	STR00	42147	A18-1300VP	None	88621	R-800
Refrigerator Mercoild with 27.5" lower opening	27.5" x 12"	33-945230	R5000	42183	A18-1312VP	08-30298	88608	None
Refrigerator Dometic with 20-inch lower opening	20" x 1.5"	33-945200	R5020 R5080	42139 42140	A18-1311VP	08-30195	None	88330
Refrigerator Dometic with 8-10" lower opening	9" x 1.5"	33-945150	R5080	42154	A18-1313VP	None	88601	R-6006
Refrigerator Mercoild with 19.75" lower opening Dometic with 15.375" lower opening	29" x 1.25"	33-945210	R5060 R5060	42148 42157	A18-1310VP	08-30298	88603	None
Water Heater Suburban Fresh source 6 gallon	6.5" x 6.3"	33-945430	WH400	42151	A18-1323VP	08-30225	88322	None
Water Heaters Atwood 6 & 10 Gallon Suburban 6 gallon	6.5" x 6.5"	33-945400	WH090	42145	A18-1320VP	08-30175	88305	W-100
Water Heaters Suburban 10 gallon, 12 gallon or 18 gallon	6.5" x 7"	33-945410	WH090	42146	A18-1321VP	08-30215	88308	W-200
MULTI Appliance Types: Furnaces: Atwood Hydroflame models 4535, 4534, 8020, 8040 DC, and 8040 AC. Water Heaters: Most Suburban low-style with lowered base. Battery Ventis: None	4.5" x 4.3"	33-945430	WH200	42150	A18-1322VP	None	88327	None

All applications available



Access Doors



Access Doors

Access door can be a replacement or an upgrade to many OEM doors. Secures small cargo compartments. Prevents the theft of stored items. Mounts easily to most trailers, RVs and other applications. Built-in lock secures important cargo areas. Built-in lock with 2 keys. Mounting holes provided for easy installation. Designed for performance and durability. Durable steel construction. Butyl tape sold separately. 8" wide x 7-1/4" tall / 5" wide x 5" tall opening. 1-Year warranty.

UF# 48-979009 White

UF# 48-979010 Chrome

Perfect for many applications



Power Mover



The safest way to move trailers around the lot

25,000lb of push/pull power
1,000lb of front lifting capacity
3,000lb Center Lift capacity



Power Mover 7900
41-007900

\$16,619
Factory Direct
Plus Freight



Precise positioning
(from seamless variable-speed adjustments positioning)

Removes bounce that damages trailer and tongue jacks

Perfect for all known types Fifth Wheel, Gooseneck and Travel Trailers

Ergonomic handle features forward / reverse controls

Includes both a 2" and 2-5/16" Hitch Ball

Forklifts are not designed to move trailers



Power Mover

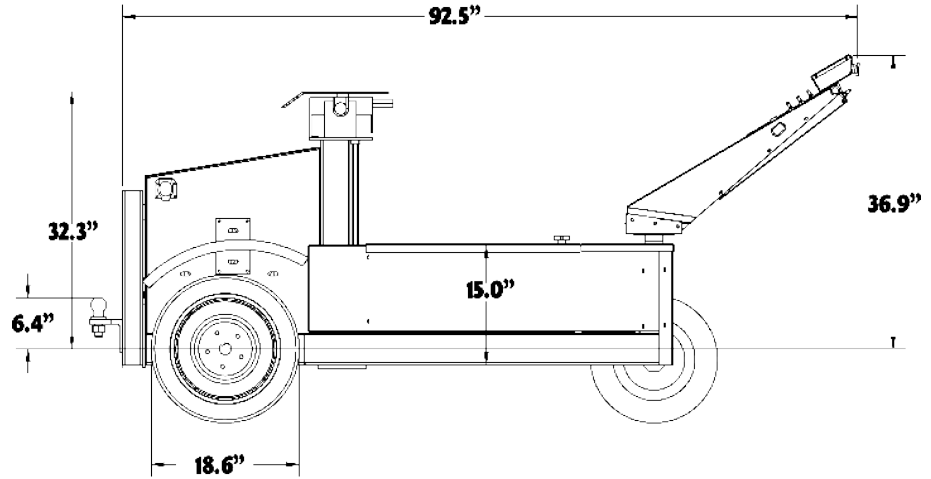
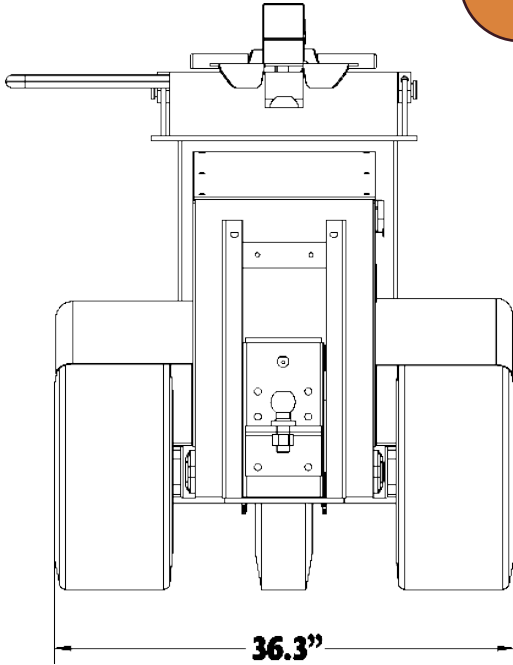

- Quad 12 VDC 140 AH batteries
- Integrated charger and level indicator
- 2 HP continuous-drive motor
- Speed up to 1.6 MPH
- Weight: 1,200lb

	
Power Mover®	Forklifts
<p>Better Positioning: Better control for positioning on lot, in showroom, etc.</p> <p>Protects Trailer: Improved control reduces potential for damage.</p> <p>Protect Jacks: Eliminates bouncing to eliminate tongue jack damage.</p>	<p>Positioning Challenge: Size of forklift makes it difficult to position trailer in tight spaces.</p> <p>Danger: Bulk of forklift and difficulty to see around trailer makes damage more likely.</p> <p>Damages Jacks: Most common reason for jack replacements is bouncing from moving trailers with forklift.</p>

Power Movers are designed to move trailers



Power Mover



The safest way to move trailers around the lot



15,000lb of push/pull power!
1,000lb front lifting capacity

Power Mover 5900
41-005905

\$9,064
Factory Direct
Plus Freight

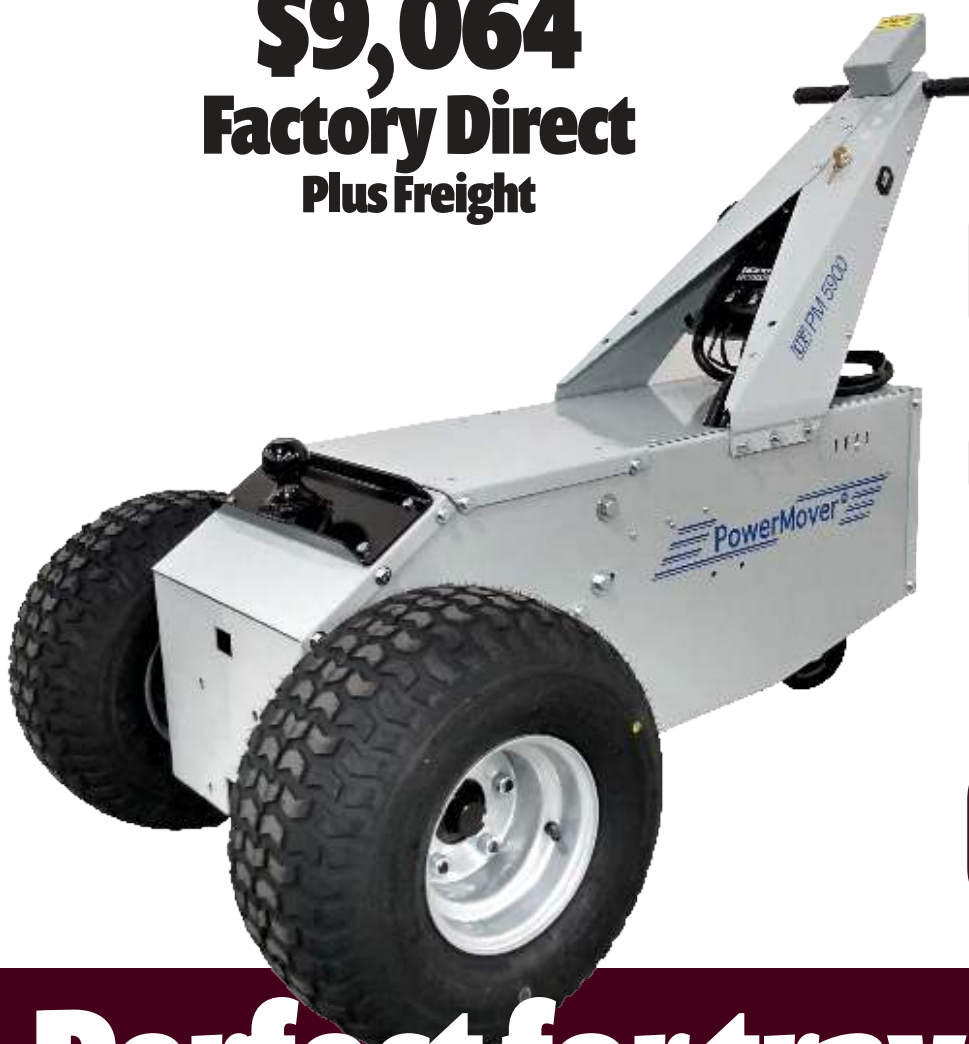

Precise positioning
(from seamless
variable-speed
adjustments
positioning)

Removes bounce
that damages
trailer and tongue
jacks

Perfect for all
known types of
travel trailers

Ergonomic handle
features forward /
reverse controls

Includes both a
2" and 2-5/16"
Ballplate

Perfect for travel trailers



Power Mover

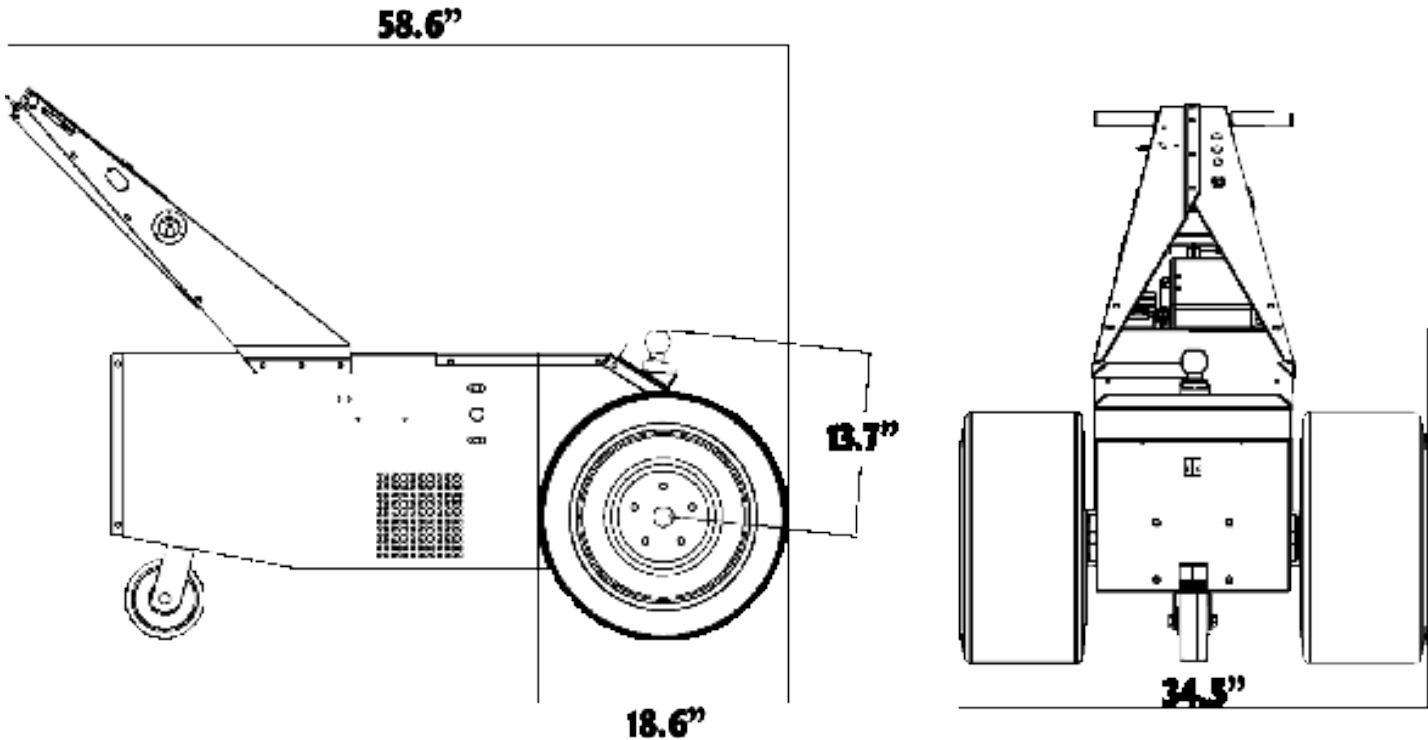

- Dual batteries (12VDC, 140AH) with integrated charger and level indicator
- 2HP continuous-drive motor can operate at 1.6MPH.
- 9½" x 18" pneumatic drive tires and rear swivel tire.
- Fixed ball mount is standard at 23" off the **floor.**
- Weight: 1,000lbs.

Comparison	
Power Mover	Forklifts
<p>Better Positioning: Better control for positioning on lot, in showroom, etc.</p>	<p>Positioning Challenge: Size of forklift makes it difficult to position trailer in tight spaces.</p>
<p>Protects Trailer: Improved control reduces potential for damage.</p>	<p>Danger: Bulk of forklift and difficulty to see around trailer makes damage more likely.</p>
<p>Protect Jacks: Eliminates bouncing to eliminate tongue jack damage.</p>	<p>Damages Jacks: Most common reason for jack replacements is bouncing from moving trailers with forklift.</p>

Compare Power Movers vs Forklifts



Power Mover Accessories



Add on for Model 5900 Replacement for Model 7900



41-880009 Foam Filled Tire (Upgrade Only) Two Tires

41-500125 Foam Filled Tire (Single Tire)

Puncture-Proof Tire. Solid **foam-filled core eliminates flats caused by nails, screws or debris.** Increases traction. Swap directly with the pneumatic tire on the Power Mover model 5900. 18" tall x 9.5" wide.

41-940439
Horn Kit

Super loud horn emits a clear audible warning, ensuring bystanders and coworkers recognize moving equipment instantly. Engineered **specifically for easy bolt-on installation** to Ultra-Fab Power Mover model 5900—no custom brackets required.



**Model 5900
or
Model 7900**

Model 5900 or Model 7900



Pintle Hook Attachment
41-013682

Adds pintle hook to Power Mover model 5900 for versatile towing options. Precision-machined hook bolts directly to the hydraulic lift assembly. Heat-treated steel with a **corrosion-resistant finish.**

Spring Caster (Heavy Duty)
41-500110

Model 5900 or Model 7900

6" shock-absorbing spring caster with polyurethane wheel reduces vibration and jolts for effortless trailer positioning. Supports high loads and enhances stability on uneven surfaces. Replaces the standard rear caster on Power Mover 5900. **Corrosion-resistant finish.**



41-810050 Strobe Light & Horn Safety Package

Bright amber strobe light draws attention to the Power Mover's presence to prevent collisions and accidents. Built-in horn emits a clear audible warning. Engineered **specifically for easy bolt-on installation** to Power Mover model 5900—no custom brackets required.

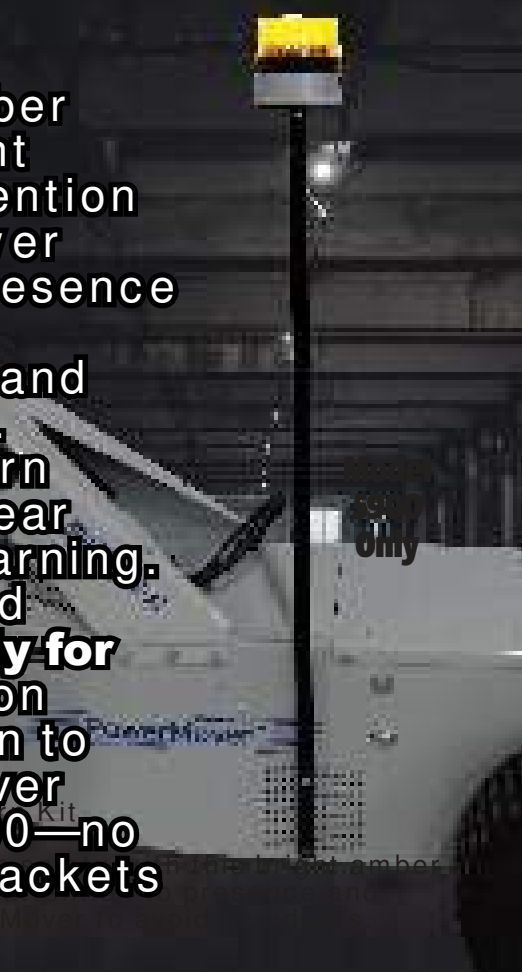

Upgrade your Power Mover for peak performance



Power Mover Accessories



- **Add on for Model 5900**
- **Included on Model 7900**

Hydraulic Lift
41-800125

Raise or lower hitch ball while never having to leave the controls of the power mover. Includes both 2" and 2-5/16" hitch balls. Adjust hitch height from 9"-13" with a 7" stroke **for flexible trailer hookup. When** mounted in the low position, lift from 9"-16". Mounted high, lift from 13"-20". Engineered exclusively for the Power Mover model 5900.



- **41-001040 224# Weight Kit for Model-5900**

Increase traction & stability by adding solid cast-iron ballast. Designed to securely mount on the Power Mover—no drilling or special tools required. Powder-coated to resist rust, corrosion, and chipping, ensuring long-term performance in dealer lots and outdoor yards.



Take your Power Mover to the next level



Trailer Brakes



From
3,500lb to
15,000lb
capacity



Brake Cross Reference							
Size	Adjust	Capacity	Pkg	Side	UF#	Dexter #	Lippert #
10" x 2.25"	Manual	3,500lbs	Bulk	Left / Driver's	48-979110	023-026-00	122258
				Right / Passenger's	48-979111	023-027-00	122450
			Boxed	Left / Driver's	48-979150	K23-026-00	296651
				Right / Passenger's	48-979151	K23-027-00	296652
10" x 2.25"	Automatic	3,500lbs	Bulk	Left / Driver's	48-979210	023-468-00	122468
				Right / Passenger's	48-979211	023-469-00	122469
			Boxed	Left / Driver's	48-979250	K23-468-00	296SA10L
				Right / Passenger's	48-979251	K23-469-00	296SA10R
12" x 2"	Manual	6,000lbs	Bulk	Left / Driver's	48-979112	023-105-00	1222593
				Right / Passenger's	48-979113	023-106-00	1222583
			Boxed	Left / Driver's	48-979152	K23-105-00	2962593
				Right / Passenger's	48-979153	K23-106-00	2962583
12" x 2"	Manual	7,000lbs	Bulk	Left / Driver's	48-979114	023-180-00	122464
				Right / Passenger's	48-979115	023-181-00	122465
			Boxed	Left / Driver's	48-979154	K23-180-00	296464
				Right / Passenger's	48-979155	K23-181-00	296465
12" x 2"	Automatic	7,000lbs	Bulk	Left / Driver's	48-979214	023-464-00	122SA12L
				Right / Passenger's	48-979215	023-465-00	122SA12R
			Boxed	Left / Driver's	48-979254	K23-464-00	296SA12L
				Right / Passenger's	48-979255	K23-465-00	296SA12R
12-1/4" x 3-3/8"	Self Adjust	8,000lbs	Bulk	Left / Driver's	48-979218	023-450-00	122277
				Right / Passenger's	48-979219	023-451-00	122279
			Boxed	Left / Driver's	N/A	K23-450-00	298277
				Right / Passenger's	N/A	K23-451-00	298279
12-1/4" x 3-3/8"	Self Adjust	10,000lbs	Bulk	Left / Driver's	48-979216	023-410-00	122505
				Right / Passenger's	48-979217	023-411-00	122506
			Boxed	Left / Driver's	N/A	K23-410-00	296505
				Right / Passenger's	N/A	K23-411-00	296506
12-1/4" x 4"	Self Adjust	10,000lbs	Bulk	Left / Driver's	48-979220	023-438-00	N/A
				Right / Passenger's	48-979221	023-439-00	N/A
			Boxed	Left / Driver's	N/A	K23-438-00	2024028240
				Right / Passenger's	N/A	K23-439-00	2024028241
12-1/4" x 5"	Self Adjust	12,000lbs	Bulk	Left / Driver's	48-979222	023-442-00	N/A
				Right / Passenger's	48-979223	023-443-00	N/A
			Boxed	Left / Driver's	N/A	K23-442-00	297998
				Right / Passenger's	N/A	K23-443-00	2979981
12-1/4" x 5"	Self Adjust	15,000lbs	Bulk	Left / Driver's	48-979224	023-406-00	N/A
				Right / Passenger's	48-979225	023-407-00	N/A
			Boxed	Left / Driver's	N/A	K23-406-00	188840
				Right / Passenger's	N/A	K23-407-00	180300

- **STOP WITH CONFIDENCE, NOT CROSSED FINGERS:** Delivers reliable, safe braking power.
- **BUILT TOUGHER THAN YOUR GRANDPA'S OLD TRUCK:** Automotive grade friction material bonded (not riveted!) for max torque, long life, and consistent braking performance.
- **MORE STOPPING POWER:** Fine tooth gear allows quick, precise settings. Plus magnets tested at 100% conductivity. Engineered to outlast all others.
- **NO ONE HAS A LONGER WARRANTY:** Backed by Ultra-Fab's 5-year warranty, because peace of mind should last longer than your last road trip playlist.

The best quality brakes on the market



Trailer Brake Kits



Brake Kits

2 packs (1 left, 1 right)

4 packs (2 left, 2 right)

Brake Kit Cross Reference											
Brake Adjust	Brake Size	Shoe Width	Brake Capacity	Side	Ultra-Fab	Ultra-Fab Non Kit #	Dexter Bulk	Dexter Boxed	Lippert Bulk	Lippert Boxed	Qty
Manual Adjust	10"	2.25"	3,500lb	Left	48-979601	48-979114	023-180-00	K23-180-00	122464	296464	1
				Right		48-979115	023-181-00	K23-181-00	122465	296465	1
Automatic Adjust	10"	2.25"	3,500lb	Left	48-979602	48-979114	023-180-00	K23-180-00	122464	296464	2
				Right		48-979115	023-181-00	K23-181-00	122465	296465	2
Manual Adjust	10"	2.25"	3,500lb	Left	48-979605	48-979210	023-468-00	K23-468-00	122468	296SA10L	1
				Right		48-979211	023-469-00	K23-469-00	122469	296SA10R	1
Automatic Adjust	10"	2.25"	3,500lb	Left	48-979606	48-979210	023-468-00	K23-468-00	122468	296SA10L	2
				Right		48-979211	023-469-00	K23-469-00	122469	296SA10R	2
Manual Adjust	12"	2"	7,000lb	Left	48-979609	48-979214	023-464-00	K23-464-00	122SA12L	296SA12L	1
				Right		48-979215	023-465-00	K23-465-00	122SA12R	296SA12R	1
Automatic Adjust	12"	2"	7,000lb	Left	48-979610	48-979214	023-464-00	K23-464-00	122SA12L	296SA12L	2
				Right		48-979215	023-465-00	K23-465-00	122SA12R	296SA12R	2
Manual Adjust	12"	2"	7,000lb	Left	48-979613	48-979254	023-464-00	K23-464-00	122SA12L	296SA12L	1
				Right		48-979255	023-465-00	K23-465-00	122SA12R	296SA12R	1
Automatic Adjust	12"	2"	7,000lb	Left	48-979614	48-979254	023-464-00	K23-464-00	122SA12L	296SA12L	2
				Right		48-979255	023-465-00	K23-465-00	122SA12R	296SA12R	2

Why buy singles when you can save on a complete job?

Standard Hubs



Fully Loaded Hubs



Axel Capacity	Bolt Circle	Brake Size	Stud Size	Threads per inch	Standard Loaded	UF#	Dexter	Lippert
3,500lb	5" x 4.5"	10.25"	1/2"	20	Standard	48-979500	008-247-05	122460
					Loaded	48-979550	008-247-1G	814200
6,000lb	6" x 5.5"	12"	1/2"	20	Standard	48-979501	008-201-09	122094
					Loaded	48-979551	008-201-2G	814202
7,000lb	8 x 6.5"	12"	1/2"	20	Standard	48-979502	008-219-04	122096
					Loaded	48-979552	008-219-1G	814203
7,000lb	8" x 6.5"	12"	9/16"	18	Standard	48-979503	008-219-13	134543
					Loaded	48-979553	008-219-2G	814204

- **SAFE, RELIABLE BRAKING POWER:** Engineered for consistent stopping performance on your trailer; because stopping shouldn't be optional.
- **STANDARD OR FULLY LOADED ASSEMBLY:** Loaded hubs come prepacked with bearings, races, grease seals and grease (preloaded). Also includes cone wheel nuts, hub cap and cotter pin. — Basically everything but the mechanic's coffee.
- **HEAVY DUTY GREY IRON CONSTRUCTION:** Precision machined hub & drum built to resist wear and extend brake life; durable strength for RVs, boats, and utility trailers.
- **ULTRA FAB CONFIDENCE GUARANTEE:** Easy installation, long lasting durability, and backed by Ultra Fab's industry leading 5 year warranty for peace of mind.

Amazing quality on Hubs



Trailer Brake / Hub Kits



2 packs
(1 left brake,
1 right brake, 2
matching hubs)

4 packs
(2 left brakes, 2
right brakes, 4
matching hubs)



Brake Size	Brake Adjust	Shoe Width	Brake Capacity	Brake Side	Hub Size	Hub Style	Hub Bolt Centers	Hub Stud Size	Ultra-Fab	Ultra-Fab Non Kit #	Dexter	Lippert	Qty
10"	Manual	2.25"	3,500lb	Left	N/A	N/A	N/A	N/A	48-979603	48-979110	023-026-00	122258	1
10"	Manual	2.25"	3,500lb	Right	N/A	N/A	N/A	N/A		48-979111	023-027-00	122450	1
N/A	N/A	N/A	N/A	N/A	10"	Loaded	5" x 4.5"	1/2"-20		48-979550	008-247-1G	814200	2
10"	Manual	2.25"	3,500lb	Left	N/A	N/A	N/A	N/A	48-979604	48-979110	023-026-00	122258	2
10"	Manual	2.25"	3,500lb	Right	N/A	N/A	N/A	N/A		48-979111	023-027-00	122450	2
N/A	N/A	N/A	N/A	N/A	10"	Loaded	5" x 4.5"	1/2"-20		48-979550	008-247-1G	814200	4
10"	Automatic	2.25"	3,500lb	Left	N/A	N/A	N/A	N/A	48-979607	48-979210	023-468-00	1222583	1
10"	Automatic	2.25"	3,500lb	Right	N/A	N/A	N/A	N/A		48-979211	023-469-00	1224503	1
N/A	N/A	N/A	N/A	N/A	10"	Loaded	5" x 4.5"	1/2"-20		48-979550	008-247-1G	814200	2
10"	Automatic	2.25"	3,500lb	Left	N/A	N/A	N/A	N/A	48-979608	48-979210	023-468-00	1222583	2
10"	Automatic	2.25"	3,500lb	Right	N/A	N/A	N/A	N/A		48-979211	023-469-00	1224503	2
N/A	N/A	N/A	N/A	N/A	10"	Loaded	5" x 4.5"	1/2"-20		48-979550	008-247-1G	814200	4
12"	Manual	2"	7,000lb	Left	N/A	N/A	N/A	N/A	48-979611	48-979114	023-180-00	122259	1
12"	Manual	2"	7,000lb	Right	N/A	N/A	N/A	N/A		48-979115	023-181-00	122451	1
N/A	N/A	N/A	N/A	N/A	12"	Loaded	8" x 6.5"	1/2"-20		48-979552	008-219-1G	814203	2
12"	Manual	2"	7,000lb	Left	N/A	N/A	N/A	N/A	48-979612	48-979114	023-180-00	122259	2
12"	Manual	2"	7,000lb	Right	N/A	N/A	N/A	N/A		48-979115	023-181-00	122451	2
N/A	N/A	N/A	N/A	N/A	12"	Loaded	8" x 6.5"	1/2"-20		48-979552	008-219-1G	814203	4
12"	Automatic	2"	7,000lb	Left	N/A	N/A	N/A	N/A	48-979615	48-979214	023-464-00	1222593	1
12"	Automatic	2"	7,000lb	Right	N/A	N/A	N/A	N/A		48-979215	023-465-00	1224513	1
N/A	N/A	N/A	N/A	N/A	12"	Loaded	8" x 6.5"	1/2"-20		48-979552	008-219-1G	814203	2
12"	Automatic	2"	7,000lb	Left	N/A	N/A	N/A	N/A	48-979616	48-979214	023-464-00	1222593	2
12"	Automatic	2"	7,000lb	Right	N/A	N/A	N/A	N/A		48-979215	023-465-00	1224513	2
N/A	N/A	N/A	N/A	N/A	12"	Loaded	8" x 6.5"	1/2"-20		48-979552	008-219-1G	814203	4

Why buy singles when you can save on a complete job?



Idler Hubs



PERFECT IDLER HUB: Light and medium-duty trailer axles—because your cargo deserves smooth rides, not roadside drama. Ideal RV hub replacement or cargo trailer hub for appropriate trailers.

IRON-CLAD CONSTRUCTION: Made from 100% iron for durability that laughs in the face of potholes, rain, and questionable parking jobs.

CUSTOMER-FRIENDLY PRICE: Affordable, reliable, and built to last—because saving money shouldn't mean sacrificing safety.



Idler Hub Cross Reference							
Capacity	Studs	Hub Diameter	Stud Diameter	Threads	UF#	Dexter #	Lippert #
2,000lb	4	4"	1/2"	20	48-979507	008-258-5UC1	LC134452
2,000lb	5	4.5"	1/2"	20	48-979508	008-259-BT	LC134453
3,500lb	5	4.5"	1/2"	20	48-979509	K08-248-95	2024029104

Built to keep you rolling



Trailer Brake Information



Step #1: Find a brand with a 5-year warranty (like Ultra-Fab)

Step #2: Determine weight capacity

- Start by looking on current hub or by measuring diameter of axle and use this guide
- 1.5" or smaller: Ask for 1,000 lb. capacity
- 1.5" - 1.75": Ask for 2,000 lb. capacity
- 1.75" - 2.375": Ask for 3,500 lb. capacity
- 2.375" - 3": Ask for 6,000 lb. capacity
- 3" - 3.5": Ask for 8,000 lb. capacity
- 3.5" - 4": Ask for 9,000 lb. capacity

Step #2: Count studs (figure 1)

Step #3: Determine number of studs

- **Count number of studs (See figure #1)**
- In examples: 5 studs

Step #4: Determine diameter

- Measure from center of stud to center of axle (see **figure #2**)
- **Double that figure for diameter**
- In example: 2.25" center of stud to center of axle is 4.5" diameter.

Step #5: Determine diameter of studs

- **Measure size of individual studs (See figure 3).**
- If possible, determine thread pattern (either 18 or 20 grooves per inch, most being 20)

Step #6: Idler & Drum

- Note if this is an idler hub (no brake) or a hub/drum (brake goes inside)

Step #7: Put it all together

- As an example, ask for 3,500 lb., 545 (5 for 5 studs & 45 for 4.5" diameter), 1/2" (length of bolts), 20 (thread count).
- Or, to put it together 3,500 lb., 545, 1/2" - 20.



Figure 1



Figure 2

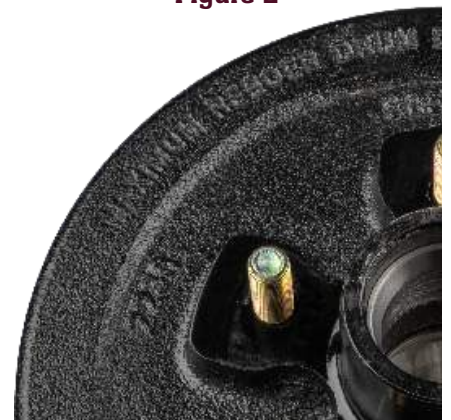

Figure 3

Making it easy to get it right the first time



Kingpin Stabilizer Tripods



Tripod Planogram

UF# 19-000006

- 2 each of our top 4 models
- 10 storage bags for quick sell
- Shelf strips and our unique shelf talker

Scissor Jack Planogram

UF# 48-979091



Bug Stopper Planogram

UF# 53-000003

- Only the 10 most popular insect screens
- Only 3 of each SKU
- Come with bright and informative header card

- 2 each of all 4 models
- Drill adapters
- Shelf strips and our one-of-a-kind shelf talker

Contact sales@ultra-fab.com



Shelf Talkers



SuperGrip Chocks

Order 4 SuperGrip chocks and get shelf talker at **no charge**.
UF# 21-001011

- One of a kind shelf talker
- Each with QR code that sends customer to a video
- Video encourages customers to purchase from you

Scissor Jacks

Order 4 Scissor Jacks and get shelf talker at **no charge**.
UF# 48-979090

Tripods

Order 3 Tripods and get shelf talker at **no charge**.
UF# 19-001093

Slide-out Supports

Order 2 Slide-out Supports and get shelf talker at **no charge**.
UF# 19-960101

Brakes

Order 12 Brakes and get shelf talker at **no charge**.
UF# 19-960102

Hubs

Order 12 hubs and get shelf talker at **no charge**.
UF# 19-960103



UF Ultra-fab
The RV Lifting, Leveling, & Stabilization Experts

THE ONLY SLIDE-OUT-SUPPORT THAT CANNOT DAMAGE THE SLIDE-OUT



SAVES WEAR AND TEAR ON SLIDE OUTS
HELPS PREVENT COSTLY SLIDE OUT AND FRAME REPAIRS
QUICK RELEASE BUTTON MAKES ADJUSTMENTS

LIFE TIME WARRANTY



UF Ultra-fab
The RV Lifting, Leveling, & Stabilization Experts

Stabilize your RV
Better than original equipment jacks



Full 6,500lb capacity per jack
Twice as fast due to exclusive double nut design
Easiest manual operation due to exclusive super tight threads

LIFE TIME WARRANTY



UF Ultra-fab
The RV Lifting, Leveling, & Stabilization Experts

ELIMINATE MOVEMENT IN CAP OF FIFTH WHEEL



STRONGEST TRIPOD (19-00001)
STABILIZES FRONT-TO-BACK AND SIDE-TO-SIDE
AUTOMATICALLY ADJUSTS TO UNEVEN GROUND
FASTEST TO SET-UP (AS LITTLE AS 70 SECONDS)

LIFE TIME WARRANTY



Contact sales@ultra-fab.com



POP Materials



Solar Vent Fan Displayer
Buy 6 and get displayer at no charge

UF# 53-945082

Buy 4 jacks,
get jack tower or gondola display
at no charge

Power Jack Gondola
Buy 4 jacks, get shelf, sign, trifold stands and 100 trifolds at no charge. Simple contact us to replenish trifolds

- UF# 38-944100 (Madix 3')
- UF# 38-944101 (Madix 4')
- UF# 38-944102 (Lozier 3')
- UF# 38-944103 (Lozier 4')



We guarantee you sell the product



Planograms



4' Ultra-Store



- Only our fastest moving products
- Guaranteed Sales
- Great signage

Includes

- 2 units UF# 19-950001 Tripod Stabilizer (Steel)
- 2 units UF# 19-950500 Tripod Stabilizer
- 4 units UF# 19-950800 Storage Bag for Tripod Stabilizers
- 2 units UF# 19-960003 Slide Out Supports (26"-47")
- 2 units UF# 19-960004 Storage Bag for Slide-out Supports
- 2 units UF# 21-001090 Super Grip Chock (1/pack)
- 2 units UF# 21-001091 Super Grip Chock (2/pack)
- 4 units UF# 21-001097 Storage Bag (Super Grip)
- 2 units UF# 38-944060 Tongue Jack Ultra Series, 3500lb
- 4 units UF# 38-944020 Cover (for power jacks)
- 2 units UF# 48-979002 Scissor Jacks (24", 2/pk)
- 3 units UF# 48-979005 Drill Attachment (Speed Socket)
- 3 units UF# 48-979071 Drill Attachment (T Slot)
- 8 units UF# 53-945096 4' Shelf Strip
- 1 unit UF# 19-001093 Shelf Talker for Tripods
- 1 unit UF# 19-960101 Shelf Talker for Slide-out Supports
- 1 unit UF# 21-001011 Shelf Talker for Tire Locking Chocks

Perfect for smaller stores



Planograms



4' Ultra-Store

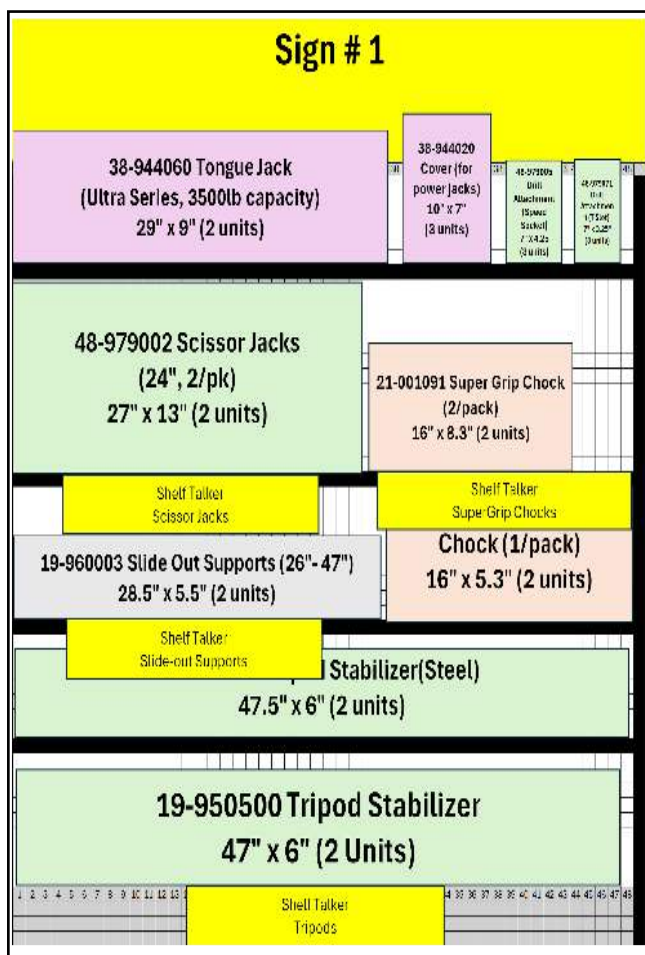

Dealers love us because we:

- **Protect your reputation:** By always having the highest quality products in our categories (as seen by our always having the longest warranties) and we usually **have unique benefits that cannot be matched.**
- **Protect your profits:** By enforcing our MAP policy.
- **Best display materials:** Provide you with the best display materials available, including our one-of-a-kind shelf talkers.
- **Guarantee the sale:** If anything doesn't sell for you within 12 months, we will exchange it for items that total equal value that will sell.
- **Best customer service:** And we provide the best customer service experience in the industry.

Contact sales@ultra-fab.com for pricing



Planograms



Includes

- 2 units UF# 19-950001 Tripod Stabilizer (Steel)
- 2 units UF# 19-950500 Tripod Stabilizer
- 4 units UF# 19-950800 Storage Bag (Tripod)
- 2 units UF# 19-960002 Slide Out Supports (21" - 37")
- 2 units UF# 19-960003 Slide Out Supports (26" - 47")
- 2 units UF# 19-960004 Storage Bag (Slide Out Support)
- 2 units UF# 21-001091 Super Grip Chock (2/pack)
- 2 units UF# 21-001090 Super Grip Chock (1/pack)
- 4 units UF# 21-001097 Storage Bag (Super Grip)
- 2 units UF# 38-944014 Tongue Jack (Ultra Series, 4000 lb.)
- 2 units UF# 38-944060 Tongue Jack (Ultra 3500lb)
- 4 units 38-944020 Cover (for power jacks)

8' Ultra-Store



Continued on next page



Medium size stores love this POG



Planograms



8' Ultra-Store



From previous page

- 2 units UF# 48-979002 Scissor Jacks (24", 2/pk)
- 2 units UF# 48-979006 Scissor Jacks (24", 1/pk)
- 3 units UF# 48-979071 Drill Attachment (T Slot)
- 2 units UF# 48-979005 Drill Attachment (Speed Socket)
- 8 units UF# 53-945096 4' Shelf Strip
- 2 units N/A Signs for gondola top
- 1 units UF# 48-979090 Shelf Talker (Scissor Jacks)
- 1 units UF# 19-001093 Shelf Talker (Tripods)
- 1 units UF# 19-960101 Shelf Talker (Slide-Outs)
- 1 units UF# 21-001011 Shelf Talker (Chocks)

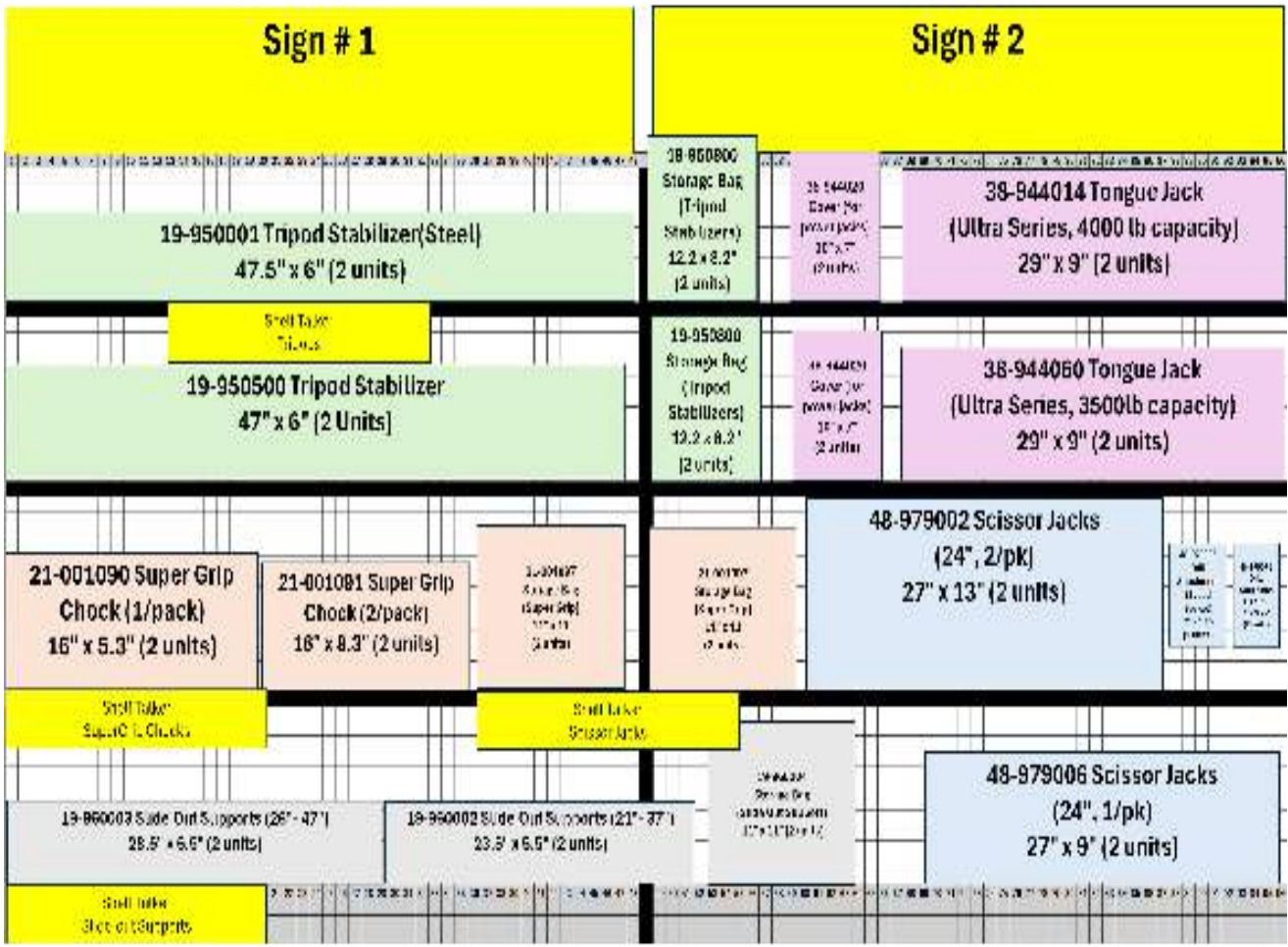

Contact sales@ultra-fab.com for pricing



Planograms



Includes

- 2 units UF# 19-950001 Tripod Stabilizer (Steel)
- 2 units UF# 19-950500 Tripod Stabilizer
- 2 units UF# 19-950450 Tripod Stabilizer (Gooseneck)
- 2 units UF# 19-950800 Storage Bag (Tripod Stabilizers)
- 2 units UF# 21-001090 Super Grip Chock (1/pack)
- 2 units UF# 21-001091 Super Grip Chock (2/pack)
- 2 units UF# 21-001095 Super Grip Chock (XL, 2/pack)
- 2 units UF# 21-001097 Storage Bag (Super Grip)
- 2 units UF# 19-960002 Slide Out Supports (21" - 37")
- 2 units UF# 19-960003 Slide Out Supports (26" - 47")
- 4 units UF# 19-960004 Storage Bag (Slide Out Support)
- 2 units UF# 48-979006 Scissor Jacks (24", 1/pk)
- 2 units UF# 48-979031 Scissor Jacks (30", 2/pk)
- 2 units UF# 48-979002 Scissor Jacks (24", 2/pk)
- 3 units UF# 48-979005 Drill Attachment (Speed Socket)

Continued on next page

12' Ultra-Store



Larger stores can maximize their sales



Planograms



12' Ultra-Store



Continued from previous page

- 3 units UF# 48-979071 Drill Attachment (T Slot)
- 2 units UF# 48-979003 Stacker Jacks (2/pack)
- 2 units UF# 48-979004 Stacker Jacks (4/pack)
- 2 units UF# 35-946510 MegaHitch Coupler Vault
- 2 units UF# 38-944060 Tongue Jack (Ultra, 3500lb)
- 2 units UF# 38-944014 Tongue Jack (Ultra, 4000 lb)
- 2 units UF# 38-944040 Tongue Jack (Phoenix, 4000 lb)
- 2 units UF# 38-944020 Cover (for power jacks)
- 11 units UF# 53-945096 4' Shelf Strip
- 2 units N/A Signs for gondola top
- 1 units N/A Gondola Display (Tongue Jacks)
- 1 units UF# 19-001093 Shelf Talker (Tripods)
- 1 units UF# 19-960101 Shelf Talker (Slide-out Supports)
- 1 units UF# 21-001011 Shelf Talker (Tire Locking Chocks)

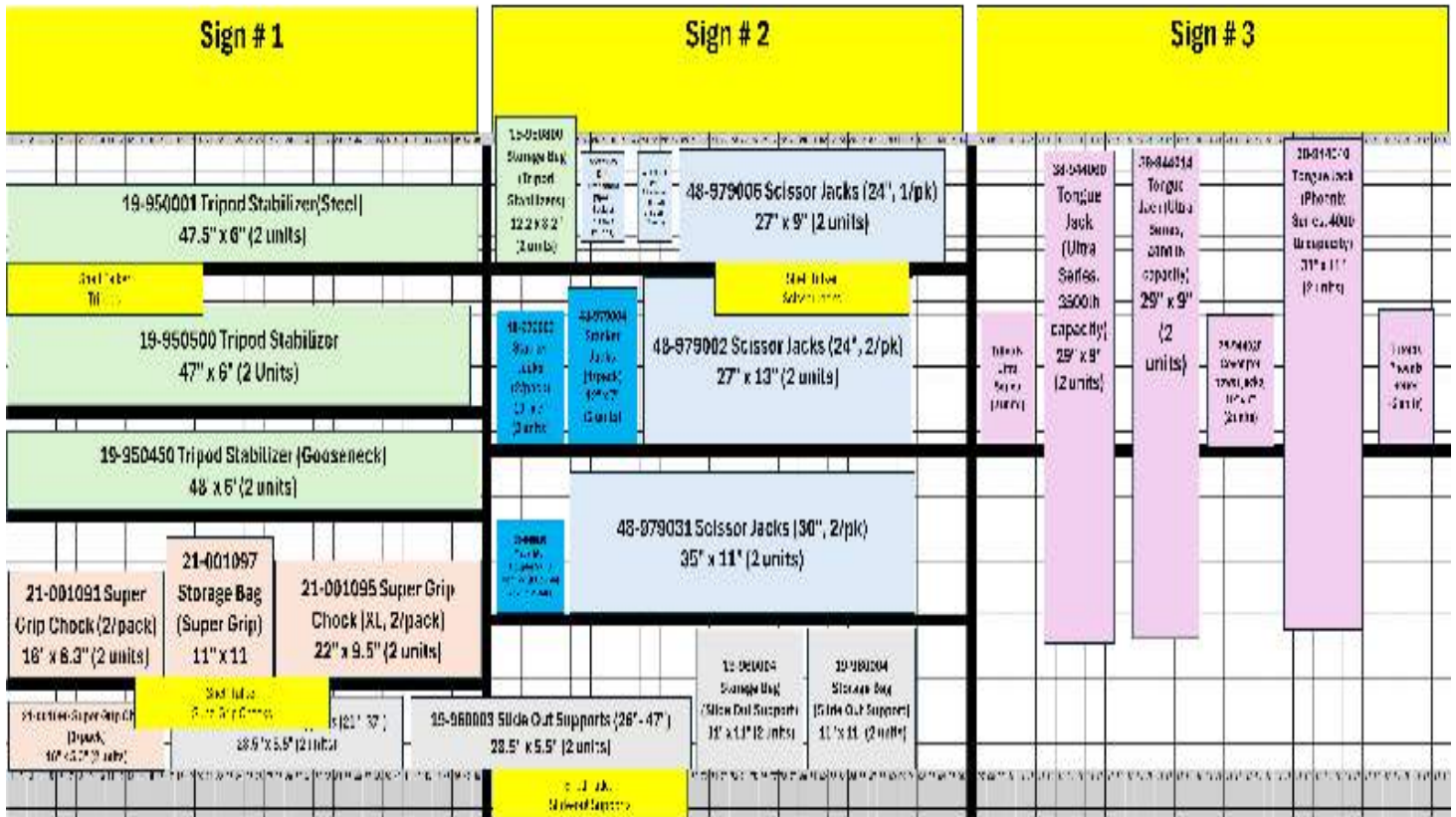

Contact sales@ultra-fab.com for pricing



Planograms



Includes

- 2 units UF# 19-950001 Tripod Stabilizer (Steel)
- 2 units UF# 19-950500 Tripod Stabilizer
- 2 units UF# 19-950450 Tripod Stabilizer (Gooseneck)
- 2 units UF# 19-950600 Tripod Stabilizer (Adjustable)
- 2 units UF# 19-950800 Storage Bag (Tripod Stabilizers)
- 2 units UF# 21-001090 Super Grip Chock (1/pack)
- 2 units UF# 21-001091 Super Grip Chock (2/pack)
- 2 units UF# 21-001094 Super Grip Chock (XL, 1/pack)
- 2 units UF# 21-001095 Super Grip Chock (XL, 2/pack)
- 4 units UF# 21-001097 Storage Bag (Super Grip)
- 2 units UF# 19-960001 Slide Out Supports (16" - 28")
- 2 units UF# 19-960002 Slide Out Supports (21" - 37")
- 2 units UF# 19-960003 Slide Out Supports (26" - 47")
- 4 units UF# 19-960004 Storage Bag (Slide Out Support)
- 2 units UF# 48-979002 Scissor Jacks (24", 2/pk)
- 2 units UF# 48-979006 Scissor Jacks (24", 1/pk)
- 2 units UF# 48-979031 Scissor Jacks (30", 2/pk)
- 3 units UF# 48-979005 Drill Attachment (Speed Socket)

Continued on next page

Continued on next page

16' Ultra-Store



Huge Stores Can Earn Huge Profits



Planograms



16' Ultra-Store



Continued from previous page

- 3 units UF# 48-979071 Drill Attachment (T Slot)
- 4 units UF# 48-979003 Stacker Jacks (2/pack)
- 4 units UF# 48-979004 Stacker Jacks (4/pack)
- 2 units UF# 38-944014 Tongue Jack (Ultra, 4000 lb.)
- 2 units UF# 38-944060 Tongue Jack (Ultra, 3500 lb.)
- 2 units UF# 38-944040 Tongue Jack (Phoenix, 4000 lb.)
- 2 units UF# 38-944055 Tongue Jack (Phoenix, 5500 lb.)
- 2 units UF# 38-944020 Cover (for power jacks)
- 2 units UF# 49-954038 Footpad (for 2.25" jacks)
- 2 units UF# 35-946510 MegaHitch Coupler Vault
- 6 units UF# 53-945001 Plumbing Vent Fan
- 15 units 53-945096 4' Shelf Strip
- 3 units N/A Signs for top of gondola
- 1 units N/A Gondola Display
- 1 units UF# 19-001093 Shelf Talker (Tripods)
- 1 units UF# 19-960101 Shelf Talker (Slide-out Supports)
- 1 units UF# 21-001011 Shelf Talker (Tire Locking Chocks)
- 1 units UF# 48-979090 Shelf Talker (Scissor Jacks)

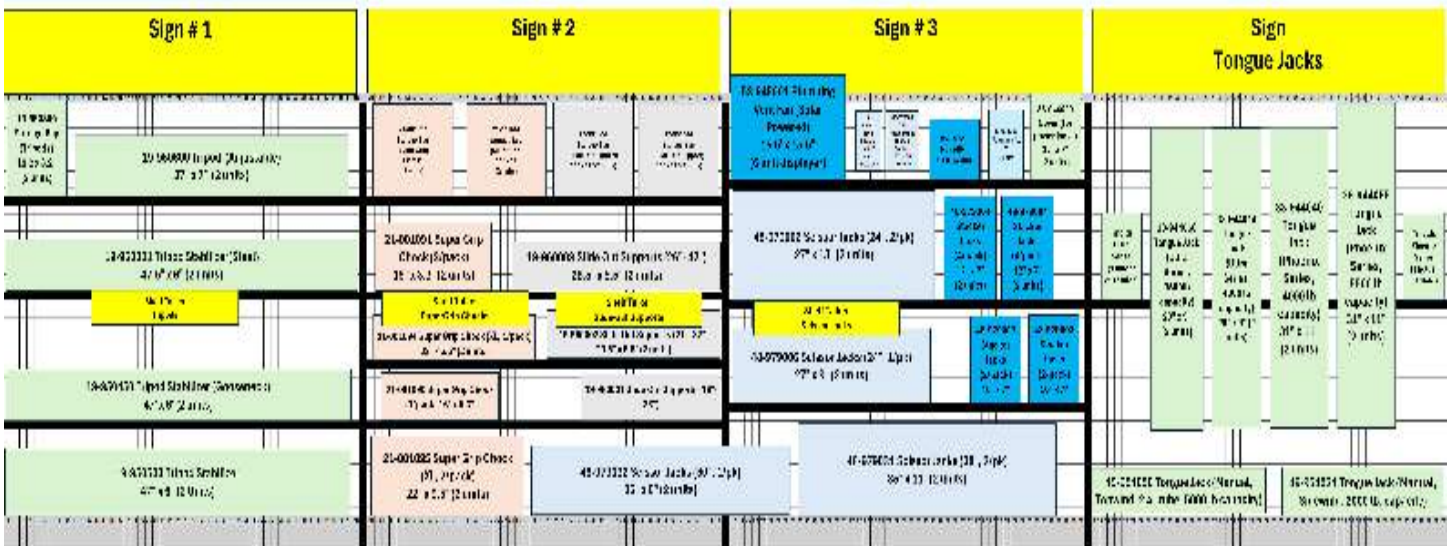

Contact sales@ultra-fab.com for pricing

UF Ultra-Fab

The RV Lifting, Leveling, & Stabilization Experts

ULTRA-STORE

THE RIGHT PRODUCTS TO HELP YOU MAKE MORE MONEY

CALLING ATTENTION TO OUR 4

PLANOGRAM STORE SIZES



Ultra-Advantage

WHEN YOU SEE THE ULTRA-ADVANTAGE LOGO YOU KNOW THOSE ARE FEATURES EXCLUSIVE TO ULTRA-FAB

A REMINDER THAT ALL PRODUCTS ARE COVERED BY OUR GUARANTEED SALE AGREEMENT



Dealers love us because Ultra-Fab:

Protects your reputation by always having the highest quality products

Protects your profits by enforcing our MAP policy

Has the best & friendliest customer service in the industry

Provides you with the best display materials available

Exclusive & valuable features not available from other manufacturers

